



**NOTES, CAUTIONS
WARNINGS &**

INDEX

TRANSMISSION MODEL

TH-355H

NOTES, CAUTIONS & WARNINGS

Appropriate service methods and proper repair procedure are essential for the safe, reliable operation of all motor vehicles as well as the personal safety of the individual doing the work.

This Manual provides general directions for accomplishing service and repair work with tested, effective techniques.

Following them will help assure reliability.

There are numerous variations in procedures, techniques, tools and parts for servicing vehicles, as well as in the skill of the individual doing the work.

This Manual cannot possibly anticipate all such variations and provide advice or cautions as to each.

Accordingly, anyone who departs from the instructions provided in this Manual must first establish that he compromises neither his personal safety nor the vehicle integrity by his choice of methods, tools or parts.



- As you read through the procedures, you will come across NOTES, CAUTIONS, and WARNINGS. Each one is there for a specific purpose. NOTES give you added information that will help you to complete a particular procedure. CAUTIONS are given to prevent you from making an error that could damage the vehicle. WARNINGS remind you to be especially careful in those areas where carelessness can cause personal injury. The following list contains some general WARNING that you should follow when you work on a vehicle.
- Always wear safety glasses for eye protection.
- Use safety stands whenever a procedure requires you to be under the vehicle with the vehicle jacked up.
- Be sure that the ignition switch is always in the OFF position, unless otherwise required by the procedure.
- Set the parking brake when working on the vehicle. It should be in REVERSE (engine OFF) or NEUTRAL (engine ON) unless instructed otherwise for a specific operation. Place wood blocks (4"X4" or larger) to the front and rear surfaces of the tires to provide further restraint from inadvertent vehicle movement.
- Operate the engine only in a well-ventilated area to avoid the danger of carbon monoxide.
- Keep yourself and your clothing away from the moving parts, when the engine is running, especially the fan and drive belts.
- To prevent serious burns, avoid contact with hot metal parts such as the radiator, exhaust manifold tail pipe, catalytic converter and muffler. Do not smoke while working on the vehicle.
- To avoid injury, always remove rings, watches, loose hanging jewelry, and loose clothing before beginning to work on a vehicle. Tie long hair securely behind the head.
- Keep hands and other objects clear of the radiator fan blades, Electric cooling fans can start to operate at any time by an increase in under hood temperatures, even though the ignition is in the OFF position. Therefore, care should be taken to ensure that the electric cooling fan is completely disconnected when working under the hood.
- Disconnect the negative battery ground cable before using any electric welding equipment.

CONTENTS

Introduction	4
Explosive view	5
Transmission Parts	6
Specifications	7
Lubrication	8
General Information	9
Torque Recommendations	10
Axial Clearances	12
Preventive Maintenance	12
Precautions	13
Inspection List	14
Turret Control Disassembly	15
Control Parts Group Disassembly	22
Primary Gear Parts Group Disassembly	24
Secondary Group Disassembly	30
Input Shaft Disassembly	31
Case Parts Group Input Shaft Disassembly	33
Extension Disassembly	36
Reassembly Reverse Gear	38
Troubleshooting Guide	57
Tools	60

INTRODUCTION

This manual is designed to provide detailed information necessary to service and repair the **TREMEC 3650** transmission listed on the cover. As outlined in the Table of Contents, the manual is divided into 4 main sections:

- a) **Technical Information and reference**
- b) **Disassembly and reassembly of the transmission**
- c) **Troubleshooting guide**
- d) **Tools required**

The format of the manual is designed to be followed in its entirety if complete disassembly and reassembly of the transmission is necessary. But if only one component of the transmission needs to be repaired, see the Table of Contents for the page numbers showing that component. For example, if you need to work on the Shifting Controls, you will find instructions for removal, disassembly, and reassembly on page into. Service manuals, Illustrated part list, drivers instructions, and other forms service information for theses and other **TREMEC** transmission are available upon request.

On any repair or parts replacement, always use "original" **TREMEC** parts according to the corresponding "Service part Catalog".

The use "non original" parts may endanger the operation and performance of the transmission.

TRANSMISIONES Y EQUIPOS MECANICOS, S.A. DE C.V. DOES NOT GUARANTEE service parts or failures resulted for a misuse or not being provided by an authorized **TREMEC** distributor.

A product literature order from, service bulletins (detailing information on product improvements), repair procedures, and other service related subjects can be obtained by writing to the following address:

PLANT AND GENERAL OFFICES:

TRANSMISIONES Y EQUIPOS MECANICOS, S.A. DE C.V.
Av. 5 de Febrero No. 2115
C.P. 76120, Querétaro, Qro.
MEXICO



NOMENCLATURE:

Letter designations

Number designations

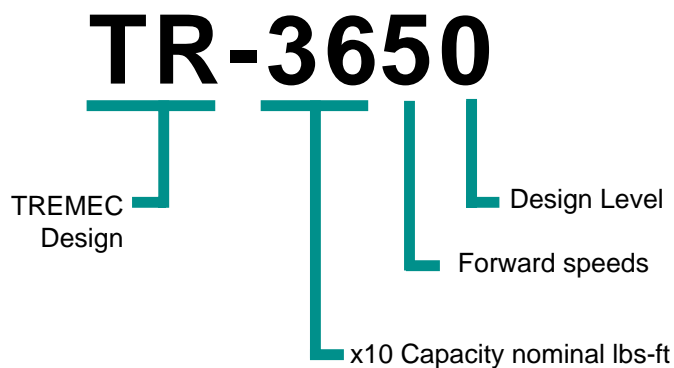

EXPLOSIVE VIEW

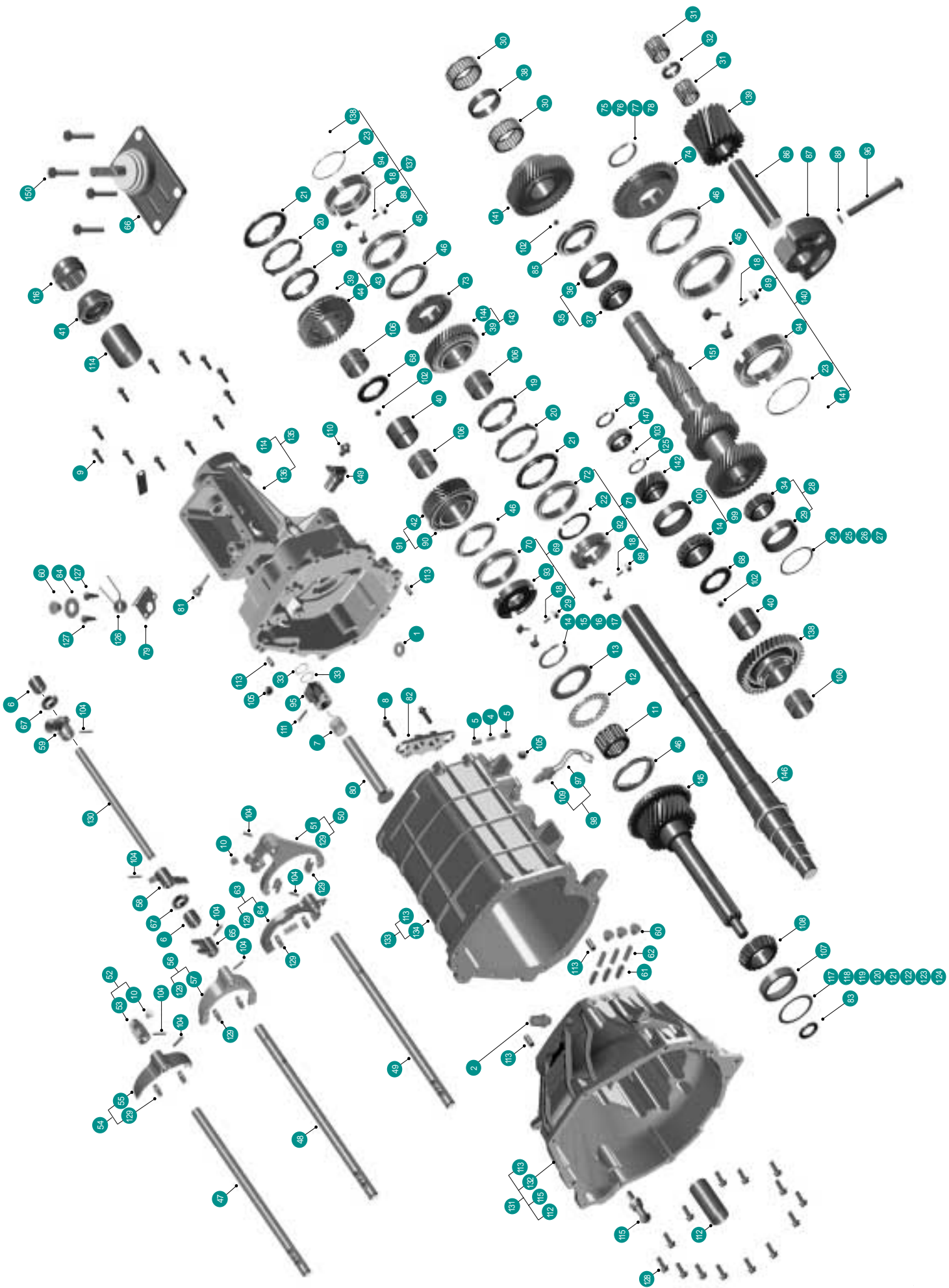

TRANSMISSION TR-3650 PARTS

1	1	MAGNET	73	1	1st. & 2nd. GATE *
2	1	ROLL PIN	74	1	1st. & 2nd. FORK SHIFT ASS'Y
3	8	ROLL PIN	75	1	1st. & 2nd. FORK SHIFT *
4	1	SNAP RING SPEEDOMETER	76	1	3th. & 4th. FORK SHIFT ASS'Y
5	1	TAG IDENTIFICATION	77	1	3th. & 4th. FORK SHIFT *
6	1	CENTER INTERLOCK PIN	78	1	SELECTOR RAIL
7	2	SHIFTER INTERLOCK	79	1	ARM SELECTOR INHIBITOR
8	1	BEARING ROLLER CUP *	80	1	SEAT SELECTOR GATE
9	2	ROLLER BEARING SELECTOR ARM	81	4	DETENT PLUG
10	1	SPRING INHIBITOR	82	3	DETENT
11	14	BOLT METRIC HEX WASHER HD	83	3	ACTUATING SPRING
12	2	NYLON STOP	84	1	REVERSE FORK SHIFT ASS'Y
13	1	BEARING INPUT SHAFT POCKET	85	1	REVERSE FORK SHIFT *
14	1	THRUST BEARING ASS'Y	86	1	3 rd & 4th. GATE
15	1	THRUST WASHER SHAFT PILOTED	87	1	SHIFTER LEVER ASS'Y
16	AR	SNAP RING 2.30+/-0.05 MM AS REQU.	88	2	SPACER FONT
17	AR	SNAP RING 2.40+/-0.05 MM AS REQU.	89	2	THRUST WASHER 3 rd GEAR & REV.
18	AR	SNAP RING 2.50+/-0.05 MM AS REQU.	90	1	3 rd & 4th. SYNCHRONIZER ASS'Y
19	AR	SNAP RING 2.60+/-0.05 MM AS REQU.	91	1	3 rd & 4th. SLEEVE *
20	12	SPRING SYNCHRONIZER	92	1	1st. & 2nd. SYNCHRONIZER ASS'Y
21	2	1st. & 2nd. INNER RING	93	1	1st. & 2nd. SLEEVE*
22	2	BLOCKER RING & LINING ASSY 1st. & nd.	94	1	SYNCHRONIZER ASS'Y REVERSE GEAR
23	2	1st. & 2nd. BLOCKER RING	95	1	REVERSE CLUTCH CONE
24	1	SNAP RING HUB SYNCHRO 1st. & 2nd.	96	1	CLUTCH CONE 5th. SPEED. C.S.
25	2	SNAP RING TOP INSERT	97	1	SPRING BASE TURRET
26	1	BEARING CONE & CUP ASS'Y MAIN SHAFT	98	1	RAIL REVERSE INHIBITOR
27	1	BEARING CONE*	99	1	INHIBITOR REVERSE
28	AR	BEARING SHIM C.S. AS REQUIRED	100	1	PIN INHIBITOR RETAINER BAR
29	AR	BEARING SHIM C.S. AS REQUIRED	101	1	INTERLOCK SUPPORT
30	AR	BEARING SHIM C.S. AS REQUIRED	102	1	OIL SEAL BEARING RETAINER
31	AR	BEARING SHIM C.S. AS REQUIRED	103	1	WASHER SPRING RETENTION
32	1	BEARING CONE & CUP ASS'Y C.S.	104	1	GEAR REVERSE M.S.
33	1	CUP BEARING *	105	1	THRUST WASHER 5th. GEAR C.S.
34	2	ROLLER BEARING GEAR 5th. C.S.	106	1	REVERSE SHAFT RAIL
35	2	ROLLER BEARING GEAR REV. IDLER	107	1	BOLT M8X1.25X60 TORX BOTTON HEAD
36	1	SPACER ROLLER BEARING GEAR REV.	108	1	REVERSE SUPPORT SHAFT
37	2	O'RING INHIBITOR	109	1	O'RING
38	1	CONE BEARING*	110	12	INSERT SYNCHRONIZER
39	1	BEARING CONE & CUP ASS'Y REAR C.S.	111	1	3 rd CLUTCH CONE *
40	1	CUP BEARING REAR C.S.*	112	1	3 rd GEAR SPEED ASS'Y M.S.
41	1	CONE BEARING REAR C.S.*	113	1	1st. & 2nd. HUB SYNCHRO *
42	1	SPACER ROLLER BEARING 5th. C.S.	114	1	3 rd & 4th. HUB SYNCHRO *
43	1	REVERSE IDLER GEAR	115	2	5th.. & REV. HUB SYNCHRO *
44	2	1st. & 2nd. CLUTCH CONE	116	3	BALL
45	1	1st. GEAR SPEED ASS'Y M.S.	117	1	BALL SPEEDOMETER
46	1	1st. GEAR SPEED M.S. *	118	2	DRAIN PLUG & FILLER PLUG
47	2	BUSHING 3 rd GEAR & REV.	119	1	BREATHER
48	1	CLUTCH HOUSING ASS'Y	120	4	2nd. & 3 rd NEEDLE BEARING ASS'Y
49	1	CLUTCH HOUSING *	121	1	BEARING TAPERED ROLLER CUP
50	1	TRANSMISSION CASE ASS'Y	122	1	BEARING TAPERED ROLLER CONE
51	1	TRANSMISSION CASE *	123	1	CAP SCREW HEX HEAD SENSOR
52	1	EXTENSION ASS'Y	124	1	SWITCH ASS'Y BACKUP LAMP
53	1	EXTENSION *	125	1	TUB RETAINER BEARING*
54	1	MAIN SHAFT	126	4	DOWEL PIN
55	1	SPEEDOMETER ROTOR GEAR	127	1	BUSHING EXTENSION HOUSING
56	1	OIL SEAL EXTENSION	128	1	STUD CLUTCH RELEASE LEVER
57	1	INPUT SHAFT	129	1	SEAL OUTPUT SPLINE
58	1	3 rd GEAR SPEED. M.S.*	130	AR	BEARING SHIM 0.55 +/- 0.013 MM
59	1	2nd. GEAR SPEED. ASS'Y M.S.	131	AR	BEARING SHIM 0.61 +/- 0.013 MM
60	1	2nd. GEAR SPEED. M.S. *	132	AR	BEARING SHIM 0.66 +/- 0.013 MM
61	1	5th. GEAR SPEED. M.S.	133	AR	BEARING SHIM 0.71 +/- 0.013 MM
62	1	SYNCHRONIZER ASS'Y 5th. GEAR C.S.	134	AR	BEARING SHIM 0.76 +/- 0.013 MM
63	1	5th. GEAR C.S.*	135	AR	BEARING SHIM 0.81 +/- 0.013 MM
64	2	5th: & REVERSE SLEEVE *	136	AR	BEARING SHIM 0.83 +/- 0.013 MM
65	1	CLUSTER GEAR	137	1	SNAP RING
66	4	BLOCKER RING 3 rd /4th./5th & REVERSE	138	1	SPRING CENTERING SHIFT CONTROL
67	1	1st. & 2nd. SHIFT RAIL	139	2	BOLT SHOULDER
68	1	3 rd & 4 th. SHIFT RAIL	140	14	BOLT METRIC HEX. WASHER HEAD
69	1	5th. & REV. SHIFT RAIL	141	4	BOLT METRIC HEX. WASHER HEAD
70	1	5th. FORK SHIFT ASS'Y	142	9	PAD SHIFT FORK
71	1	5th. FORK SHIFT*	143	1	SENSOR SPEEDOMETER
72	1	1st. & 2nd. GATE ASS'Y			

* SOLD ONLY IN ASS'Y

SPECIFICATIONS

The transmissions series TR-3650 have five forward speeds and one reverse, of advanced design that offers to you, the most efficient relation of capacity of partorsion-weight, that any other transmissions of 5 speeds within its rank.

IMPORTANT

All **TREMEC** transmissions **TR-3650** are identified by the model and serial number, and date. This information is stamped on the transmission identification tag and affixed to the case.

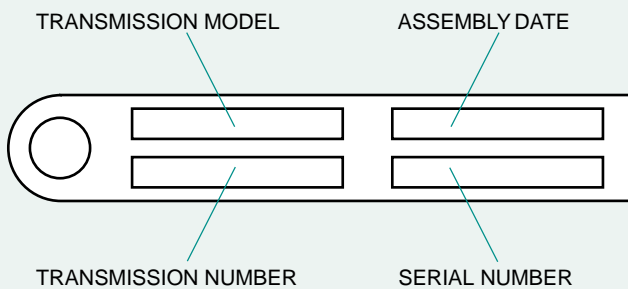

MODEL

GEAR RATIOS

	1st.	2nd.	3rd.	4th.	5th.	REV.	OIL CAPACITY
TR-3650-1/2	3.38	2.00	1.32	1.00	0.67	3.38	3800 C.C.
TR-3650-3/4/5	3.38	2.00	1.32	1.00	0.62	3.38	3800 C.C.

NOTES

- 1 Lengths measured from clutch housing face to cover rear (extension).
- 2 Weights include shift bar housing, clutch housing, less shift lever assembly, and clutch parts. For more information on available application, see the transmission's illustrated parts list. All weights are approximate.
- 3 Oil capacities are approximate, depending on inclination of engine and transmission. Always fill transmission, with proper grade and type of lubricant, to level of filler opening. See LUBRICATION.

Proper lubrication procedures are the key to a good all around maintenance program. If the oil is not doing its job, or if the oil level is ignored, all the maintenance procedures in the world are not going to keep the transmission running or assure long transmission life.

TREMEC Transmissions are designed so that the internal parts operate in an oil circulating bath by the motion of the gears and shafts.

Thus, all parts are amply lubricated if these procedures are closely followed:

- 1** Maintain oil level. Inspect regularly.
- 2** Change oil regularly.
- 3** Use the correct grade and type of oil.
- 4** Buy from a reputable dealer.

OIL SPECIFICATIONS

MODEL TRANSMISSION	API SPECIFICATION	TREMEC SPECIFICATION	OIL CAPACITY
TR-3650	Mobil 1 Synthetic ATF	ET-M-99	3.8 Lts.
	Dexron III	1300-244-006	

CHANGE AND INSPECTION OF THE LUBRICANT

Use oil ET-M99 specification. Additives and friction modifiers are not recommended for use in transmission TR-3650.

PROPER OIL LEVEL

Make sure oil is level with the filler opening. Because you can reach oil with your finger does not mean oil is at proper level.

DRAINING OIL

Drain transmission while oil is warm. To drain oil remove the drain plug at case bottom. Clean the drain plug before re-installing.

OIL CHANGE AND REFILLING

Clean case around filler plug and remove plug from case side. Fill the transmission to the level of the filler opening.

The exact amount of oil depends on the transmission inclination and model. Do not over fill this causes oil to be forced out of the case and cause a deficient lubrication. when adding oil, types and brands of oil should not be mixed because of possible incompatibility.

PROPER OIL LEVEL



IMPROPER OIL LEVEL

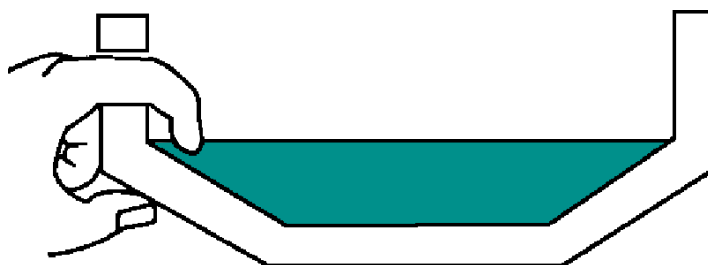

GENERAL INFORMATION

The TR-3650 transmissions have five forward speeds and one reverse, and are shifted as you would shift any synchronized transmission manual, following the simple 5 speed shift pattern.

Follow the simple 5 speed shift pattern:

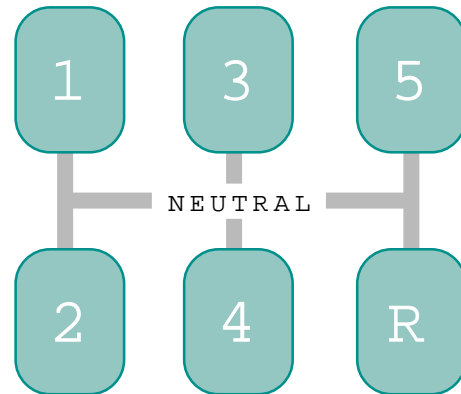

POWER FLOW

The transmission must efficiently transfer the engine's power, in terms of torque, to the vehicle's rear wheels. Knowledge of what takes place in the transmission during torque transfer is essential when troubleshooting and making repairs.

- 1 Power (torque) from the engine is transferred to the input shaft and drive gear.
- 2 Torque is transferred to the countershaft drive gear.
- 3 Torque is delivered along the countershaft to all countershaft gear.
- 4 Torque is transferred to "engaged" mainshaft gear. The cross section illustrates 1st speed gear position.
- 5 Engaged mainshaft gear internal clutching teeth transfers torque to mainshaft through synchronizer assembly.
- 6 Mainshaft transfers torque directly to driveshaft through rear yoke.

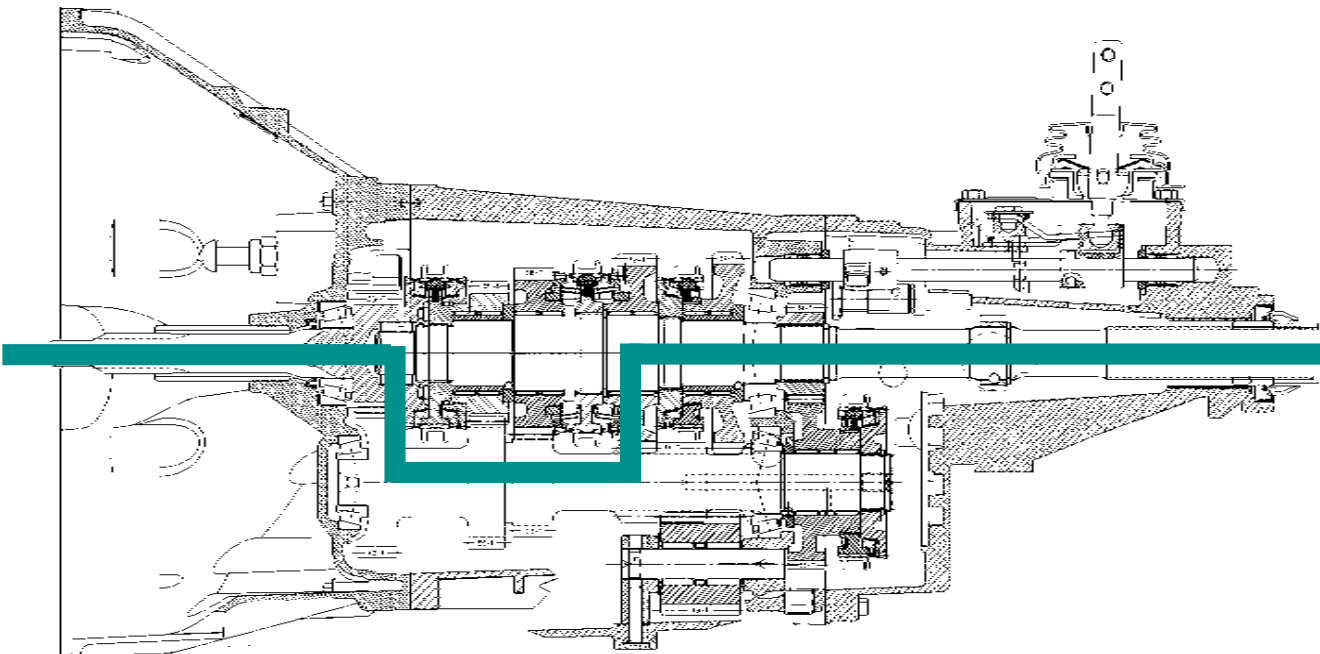

Correct torque application is important to assure long transmission life. Over or under tightening of fasteners can result in a loose installation and, in many instances, can eventually cause damage to the transmission. Use a torque

wrench to obtain recommended torque ratings. Do not torque capscrews dry. Apply teflon to threads of all capscrews before in installing definitive.

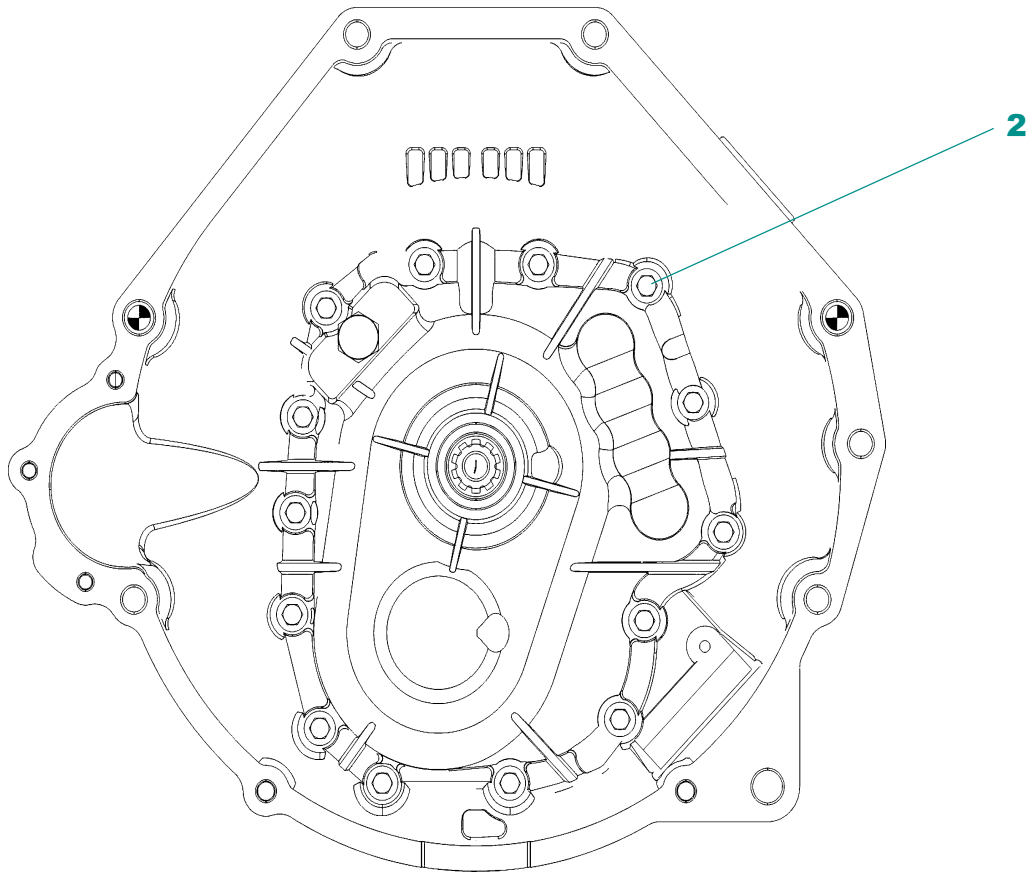

TORQUE RECOMMENDATIONS

ITEM	QTY	DESCRIPTION	TORQUE	
			Nm	Lbs/Ft
1	3	DETENT PLUGS 1/2-20 8.2 MM TORX PLUS DRIVE	20-35	15-25
2	14	CLUCTH HOUSING TO TRANSMISSION MAIN CASE BOLT M8X1.25 HEX HEAD 13	25-40	19-29
3	12	EXTENSION TO TRANSMISSION MAIN CASE BOLT M8X1.25 HEX HEAD 10 MM	25-40	19-29
4	4	GEARSHIFT LEVER TO EXTENSION HGS BOLT M8 X 1.25 HEX HEAD 10 MM	25-40	19-29
5	1	REVERSE LIGTH SWITCH M16 X 1.5 HEX HEAD 7/8"	20-35	15-23
6	1	SENSOR SPEEDOMETER BOLT M6 X 1.00 HEX HEAD 10 MM	7-14	5-10
7	1	FILL PLUG 1/2"-14 NPTF SOCKET HEAD 3/8"	20-35	15-25
8	1	DRAIN PLUG 1/2"-14 NPTF SOCKET HEAD 3/8"	20-35	15-25
9	1	REVERSE IDLER GEAR BOLT M8 X 1.25 TORX PLUS	20-35	15-25
10	1	STUD CLUTCH RELEASE LEVER 1/2 -13 UNC-2A HEX HEAD 7/8"	35-50	26-36
11	1	INTERLOCK SUPPORT BOLT M10 X 1.5 6g TORX (T40)	20-35	15-25
12	2	GUIDE PLATE BOLT SHOULDER M8 X 1.25-6H TORX	20-35	15-25
13	1	DETENT BIAS SPRING BOLT 1/2"-20 8.2 MM TORX PLUS DRIVE	20-35	15-25

APPLY TEFLON TO THREADS OF ALL CAPSCREWS BEFORE INSTALLING DEFINITIVE

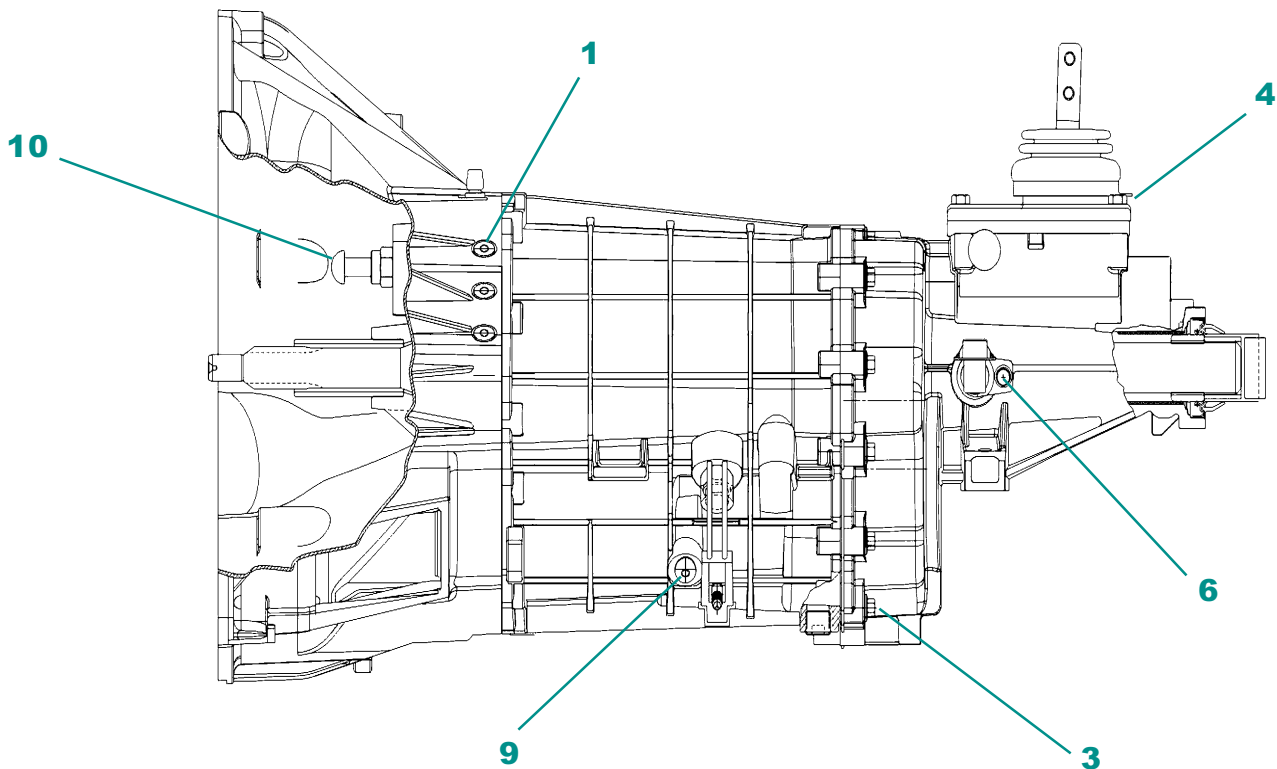

AXIAL CLEARANCES

The axial clearances will have maintain original for mainshaft gear, cluster gear and 5th. assembly gear.

DESCRIPTION	SPECIFICATION	
	(mm)	(in)
1st. GEAR SPEED	0.200-0.500008"-.019"
2nd. GEAR SPEED	0.100-0.340004"-.013"
3rd. GEAR SPEED	0.125-0.365005"-.014"
INPUT SHAFT	0.027-0.127001"-.005"
REVERSE GEAR	0.100-0.360004"-.014"
COUNTERSHAFT	0.026-0.126001"-.005"
5th.GEAR C.S.	0.112-0.742004"-.025"
REVERSE IDLER GEAR	0.100-0.660004"-.026"

PREVENTIVE MAINTENANCE

1 CLUTCH HOUSING MOUNTING

a) Check all capscrews of clutch housing flange for looseness.

2 CLUTCH RELEASE BEARING (NOT SHOWN)

a) Remove hand hole cover and ckeck radial and axial clearance in release bearing.

b) Check relative position of thrust surface of release bearing with thrust sleeve on push-type clutches.

3 CLUTCH PEDAL SHAFT AND BORES

a) Pry upward on shafts to check wear.

b) b)If excessive movement is found, remove clutch release mechanism and check bushings in bores and war on shafts.

4 LUBRICANT

a) Change at specified service intervals.

b) Use only the types and grades as recommended. See LUBRICATION.

5 FILLER AND DRAIN PLUGS

a) Remove plug filler and check level of lubricant at specified intervals. Tighten filler and drain plugs securely.

6 CAPSCREW

a) Check all capscrew, especially those turret, the clutch housing and cover rear, for looseness which can cause oil leakage.

See TORQUE RECOMMENDATIONS.

7 GEAR SHIFT LEVER

a) Check for looseness and free play in housing. If lever is loose in housing, proceed with check No.8

8 GEAR SHIFT LEVER HOUSING ASSEMBLY

a) Remove the gear shift housing assembly from transmission.

b) Check gear shift lever botton end for wear of slots. Also check finger assembly for wear

CHECK WITH DRIVE LINE DROPPED

9 UNIVERSAL JOINT COMPANION FLAGE OR YOKE NUT

- a) Check for tightness. Tighten to recommended torque rating.

10 OUTPUT SHAFT (NOT SHOWN)

- a) Pry upward against output shaft to check radial clearance in mainshaft rear bearing.

CHECK WITH UNIVERSAL JOINT COMPANION FLAGE OR YOKE REMOVED

NOTE: If necessary, use solvent and shop rag to clean sealing surface of companion flage or yoke.
DO NOT USE CROCUS CLOTH,
EMERY PAPER,
OR OTHER ABRASIVE MATERIALS THAT WILL MAR SURFACE FINISH.

11 SPLINES ON OUTPUT SHAFT (NOT SHOWN)

- a) Check for wear from movement and chucking action of the universal joint companion flage or yoke.

12 MAINSHAFT REAR BEARING COVER

- a) Check oil seal for wear.

PRECAUTIONS

It is assumed in the detailed assembly instructions that the lubricant has been drained from the transmission, the necessary linkage disconnected and the transmission has been removed from vehicle chassis.

Removal of the gear shift lever housing assembly is included in the detailed instructions (Disassembly and Reassembly-Shifting Controls); however, this assembly must be detached from shift bar housing before transmission can be removed.

Follow closely each procedure in the detailed instructions, making use of the text, illustrations, and photographs provided.

1 BEARINGS

Carefully wash and relubricate all re-useable bearing as removed and protectively wrapped until ready for use. Remove bearings planned to be reused with pullers designed for this purpose.

2 ASSEMBLIES

When disassembling the various assemblies, such as the mainshaft, countershafts, and shift bar housing, lay all parts on a clean bench in the same order as removed. This procedure simplifies reassembly and reduces the possibility of losing parts.

3 SNAP RINGS

Remove snap rings with pliers designed for this purpose. Snap rings removed in this manner can be reused, if they are not sprung or loose.

4 CLEANLINESS

Provide a clean place to work. It is important that no dirt or foreign material enters the unit during repairs. Dirt is an abrasive and can damage bearings. It is always good practice to clean the outside of the unit before starting the planned disassembly.

5 WHEN USING TOOLS TO MOVE PARTS

Always apply force to shafts, housings, etc, with restraint. Movement of some parts is restricted. Never apply force to the part being driven after it stops solidly. The use of soft hammers, bar, and mauls for all disassembly work is recommended.

Before reassembling the transmission, check each part carefully for abnormal or excessive wear and damage to determine reuse or replacement. When replacement is necessary, use only genuine **TREMEC** Transmission parts to assure continued performance and extended life from your unit.

Since the cost of a new part is generally a small fraction of the total cost of downtime and labor, avoid reusing a questionable part which could lead to additional repairs and expense soon after reassembly. To aid in determining the reuse or replacement of any transmission part, consideration should also be given to the unit's history, mileage, application, etc.

Recommended inspection procedures are provided in the following check list.

A. BEARINGS

1. – Wash all bearings in clean solvent. Check balls, rollers, and raceways for pitting, discoloration, and spalled areas. Replace bearings that are pitted, discolored, spalled, or damaged during disassembly.

2. - Lubricate bearings that are not pitted, discolored, or spalled and check for axial and radial clearances.

3. - Replace bearings with excessive clearances.

4.- Check bearing fit.

Bearing inner races should be tight to shaft; outer races slightly loose in case bore. If bearing spins freely in bore, case should be replaced.

B. GEARS

1. – Check gear teeth for frosting and pitting. Frosting of gear teeth faces present no threat of transmission failure. Often in continued operation of the unit, frosted gears “heal” and do not progress to the pitting stage. In most cases, gears with light to moderate pitted teeth have considerable gear life remaining and can be reused, but gears with advanced stage pitting should be replaced.

2. – Check for gears with clutching teeth abnormally worn, tapered, or reduced in length from clashing in shifting. Replace gear found in any of these conditions.

3. – Check axial clearance of gear.

Where excessive clearance is found, check gear snap ring, split washer, clutch hub, and gear hub for excessive wear.

C. SPLINES

1. – Check splines on all shafts for abnormal wear. If sliding clutch gears, companion flange, or clutch hub have worn into the sides of the splines, replace the specific shaft affected.

D. WASHERS

1. – Check surfaces of all washers. Washers scored or reduced in thickness should be replaced.

E. REVERSE IDLER GEAR ASSEMBLIES

1. - Check for excessive wear from action of roller bearing.

F. ASSEMBLIES CONTROL PARTS

1. - Revise desgaste en donde asienta, revise las ranuras de los topes y las horquillas, revise los insertos de las horquillas, reemplace los insertos si muestran huellas de desgaste.

G. ASSEMBLIES CONTROL TURRET

1. – When disassembled the turret, check torreta, revise si hay desgaste en el extremo bajo de la palanca, en el conjunto del dedo accionador de los cambios, reemplace la parte con desgaste excesivo.

H. BEARING CUP

1. – Check si las tazas tienen desgaste, reemplace las tazas que estén dañadas.

I. OIL SEALS

1. – Check oil in input shaft and rear bearing cover. If sealing action of lip has been destroyed, replace seal.

J. SYNCHRONIZER ASSEMBLY

1. – Check synchronizer for burrs, uneven and excessive wear at contact surface, and metal particles.

2. – Check blocker insert for excessive wear or looseness.

3.- Check synchronizer contact surfaces on the synchronizer rings for wear.

Make sure that case interiors and housings are clean. It is important that dirt and other foreign materials are kept out of the transmission during reassembly.

Dirt is an abrasive and can damage polished surfaces of bearing and washers. Use certain precautions, as listed below, during reassembly.

1 GASKET ELIMINATOR

Use gasket eliminator in all the transmission, the omission of any bead of silicone rubber to the sealing surface, can cause result in oil leakage. Use only products approved by TREMEC.

2 CAPSCREWS

To prevent oil leakage and loosening, use teflon sealant thread all capscrews. For recommended torque ratings, see TORQUE RECOMMENDATIONS.

3 ASSEMBLY

See the illustrations provided in the detailed disassembly instructions as a guide to reassembly.

4 INITIAL LUBRICATION

Coat all thrust washers, synchronizer, and bearings with transmission lubricant during reassembly to prevent damage during initial start up.

5 AXIAL CLEARANCES

Maintain original axial clearances for mainshaft gears. See specification axial clearances.

6 BEARINGS

Using a sleeve type driver that contacts the bearing inner race prevents damage to the rollers and cage.

7 SHIMS

Use shims new, until obtaining end play specified, the recorded end play measurements, select and install the appropriate shims to achieve the proper end play.

IMPORTANT:

See the appropriate illustrated parts list (specified by model series) to ensure that proper parts are used during reassembly of the transmission.

TURRET CONTROL DISASSEMBLY

BOLT METRIC HEX WASHER HEAD

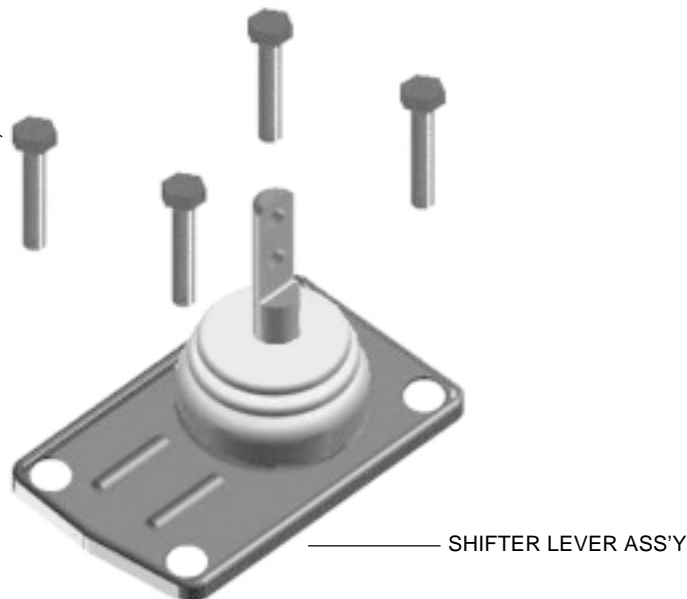

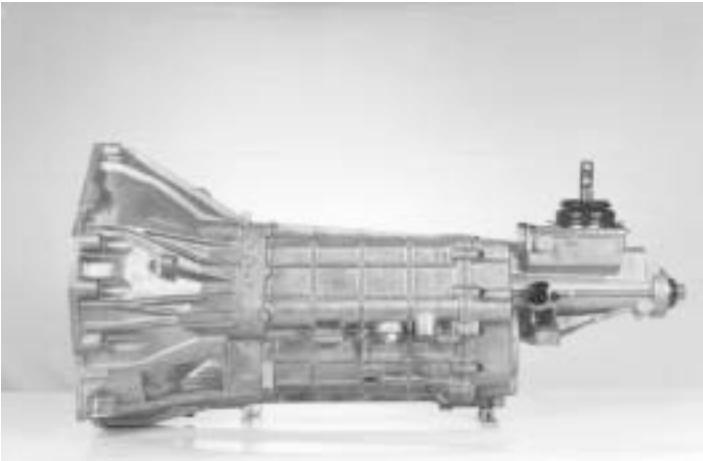

1.-Place the transmission on a work bench, as shown.

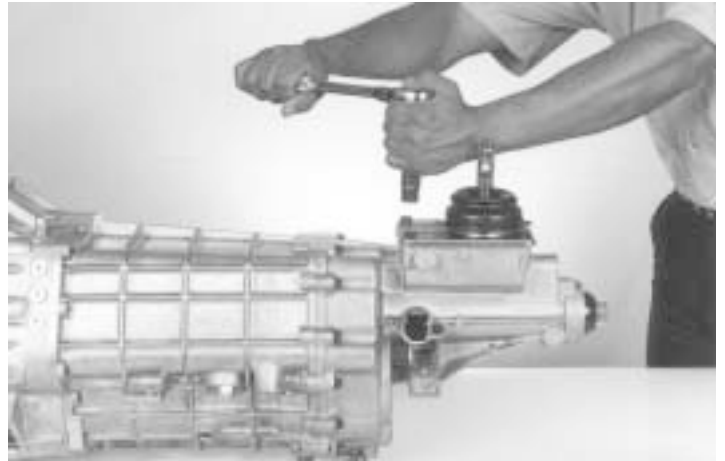

2.- Turn out the four bolts and remove, as shown.

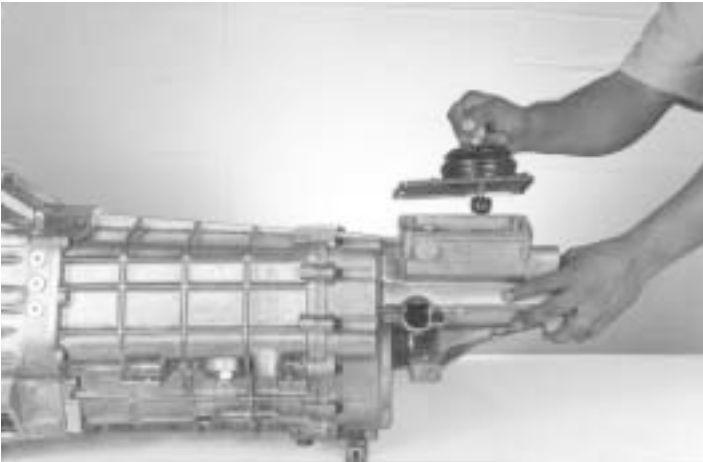

3.-Remove the control turret assembly, as indicated



4.- Rotate the transmission to a vertical position, and remove the bolt and washer, that hold the spring and plate.



5.- Using a 1/4" socket, remove the bolts, as shown.

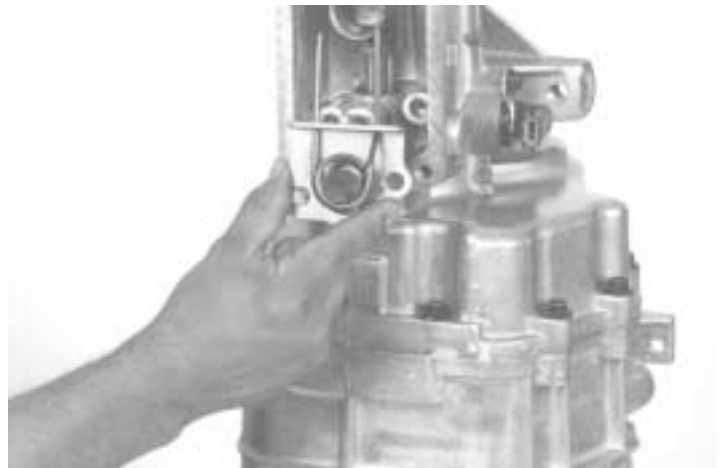

6.- Remove the shift spring and plate, as indicated.

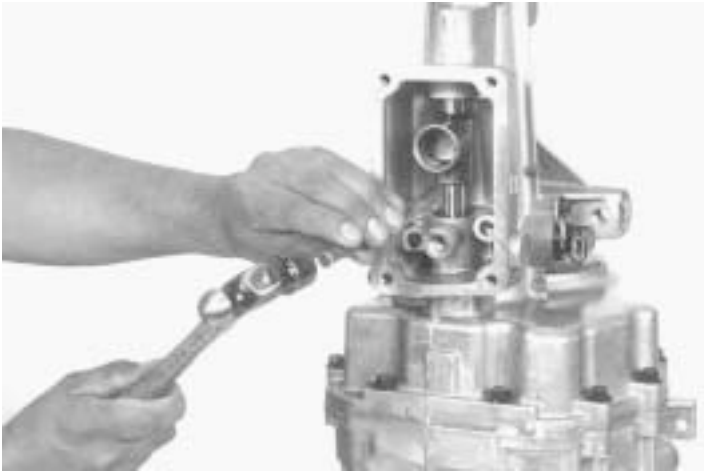

7.-Using a 5/32-inch drift and hammer, drive the split pin downward, as shown.



8.-Remove the fill plug, as indicated

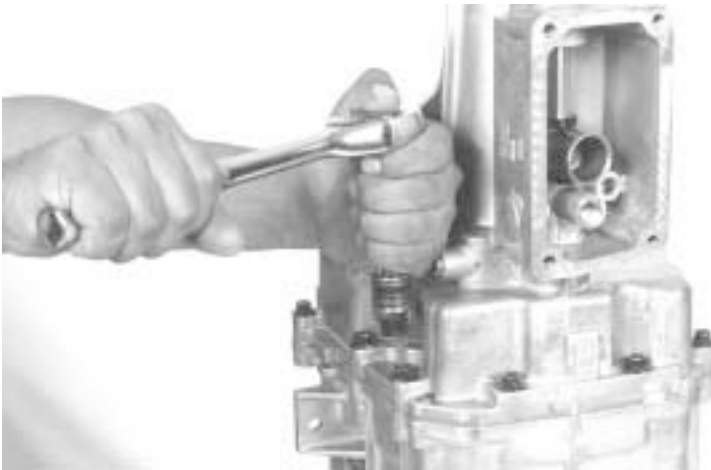

9.-Remove the 12 bolts, from extension, as shown.

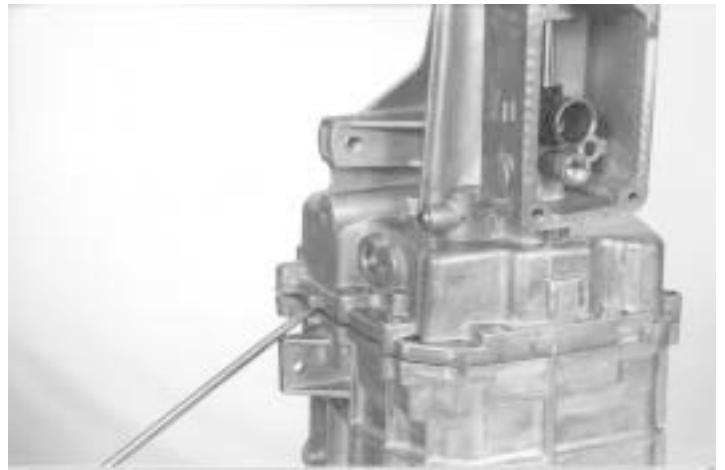

10.- Using a flat-blade screwdriver, separate the extension housing, then remove the gearshift offset lever from the transmission case.



11.-Remove the assembly extension housing, as shown.



12.- Using a snap ring plier, remove the sensor speedometer snap ring, as indicated.



13.-Using the special tools, remove the sensor speedometer, as shown.



14.-Using a magnet, remove the ball, as indicated.



15.-Using a snap ring plier, remove the snap ring of the fifth gear assembly, as shown



16.- Using a 5/32-inch drift and hammer, remove the pin from the fifth gear shift fork.

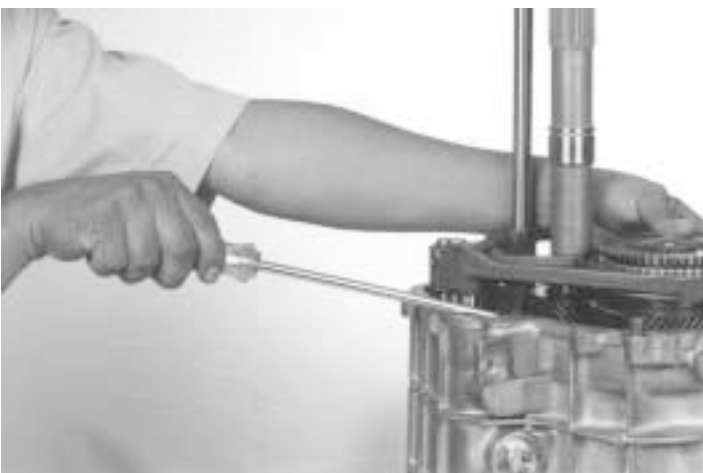

17.- Remove the fifth gear shift fork and synchronizer cone, along with the synchronizer assembly, as shown.



18.- Using a 5/32-inch drift and hammer, drive out the split pin, then remove the 3rd & 4th shift gate, as indicated



19.- Using a 5/32-inch drift and hammer, drive out the split pin then remove the 1st & 2nd shift gate.



20.- Remove the main shift rail, as indicated.



21.-Remove the plastic spacer, as shown.



22.-Remove the two needle bearings and the spacer, as indicated.



23.- Using a magnet, remove the ball, as shown.

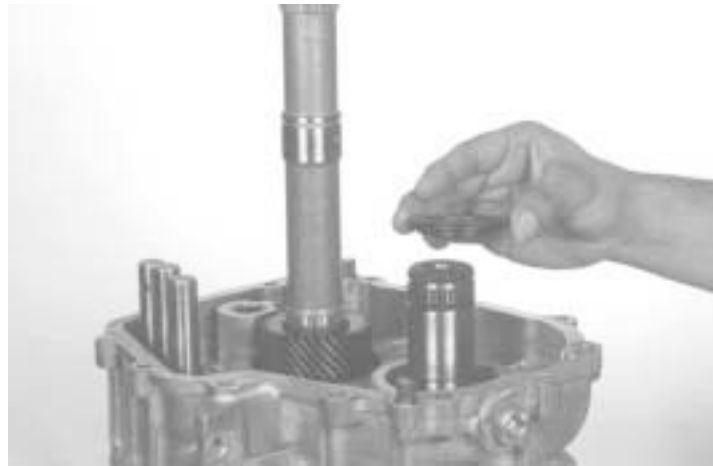

24.-Remove the thrust washer, as indicated.



25.-Remove the two bolts from the shift interlock plate, as shown.



26.- Remove the shift interlock plate, as indicated



27.- Using a magnet, remove the interlock pins, as shown.



28.-Position the interlock, and lock pin on the center rail, two between the rails.

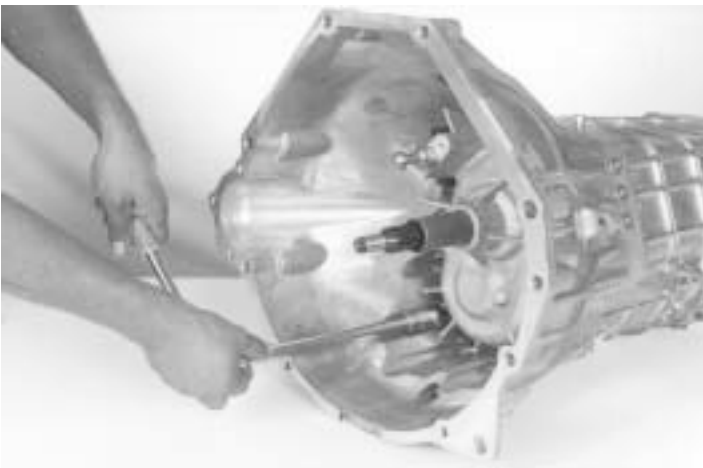

29.- Rotate the transmission to a horizontal position. Remove 12 bolts, leaving two opposing bolts in. Rotate the transmission to a vertical position, then remove the remaining two bolts.



CAUTION:

Do not remove all bolts while the horizontal position.

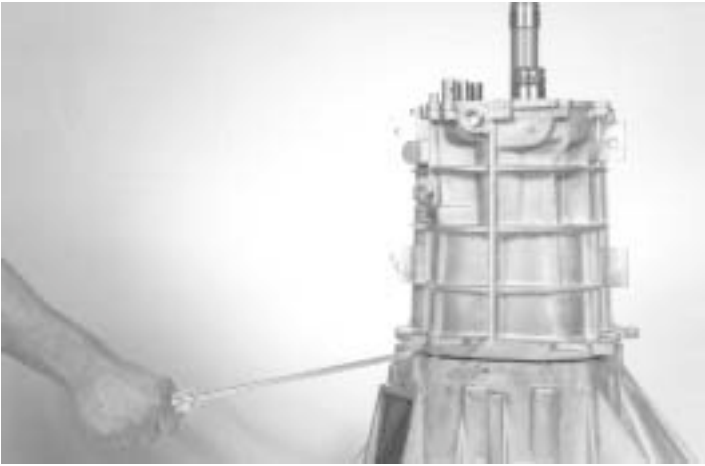

30.- Carefully pry the clutch housing from the transmission main case, as shown.



31.- Remove the transmission case from the clutch housing, as indicated. Use a hook to hold the bearing cone to avoid interference with the cluster gear.

CONTROL PARTS GROUP DISASSEMBLY

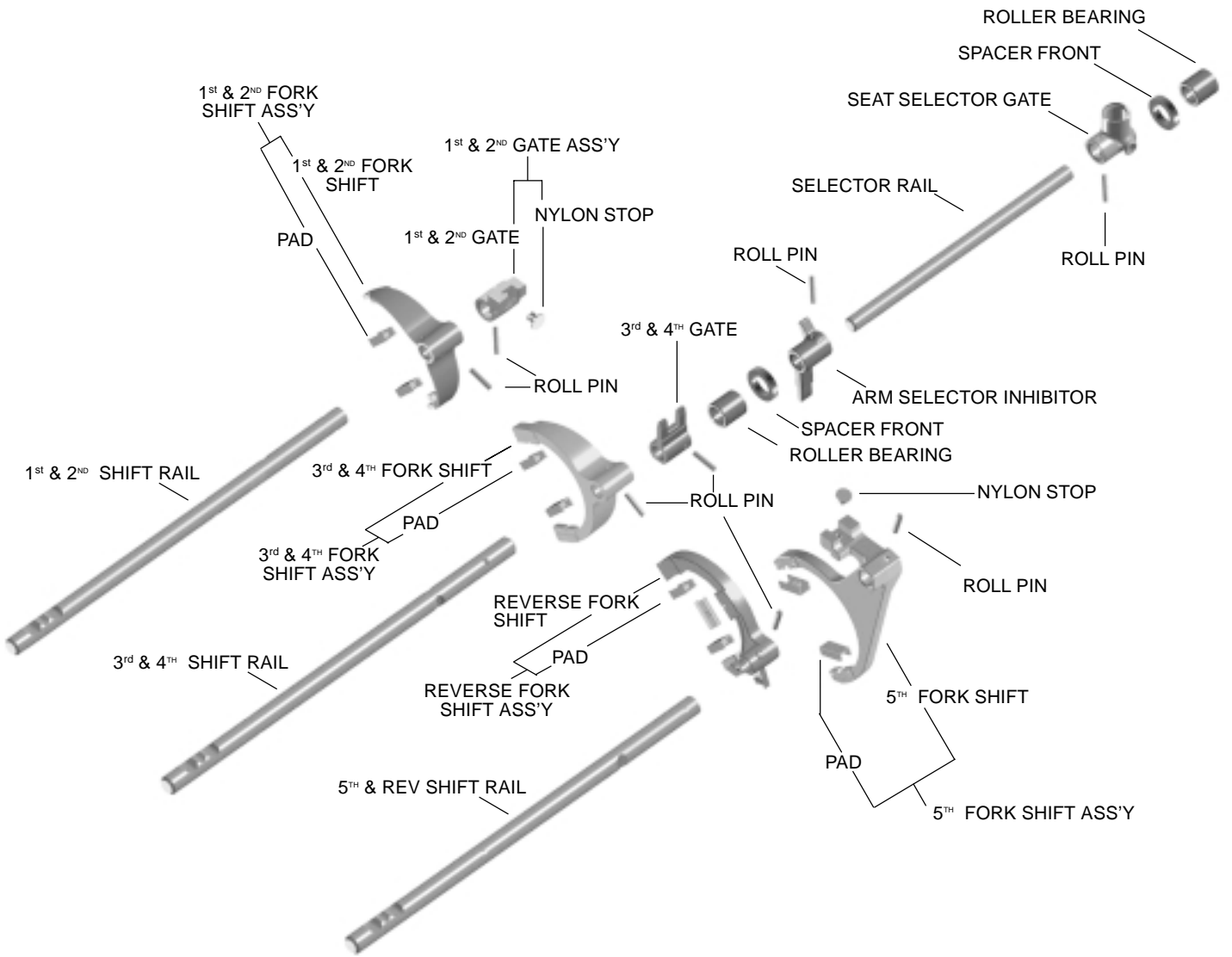

32.- Remove the three detent plugs, as shown

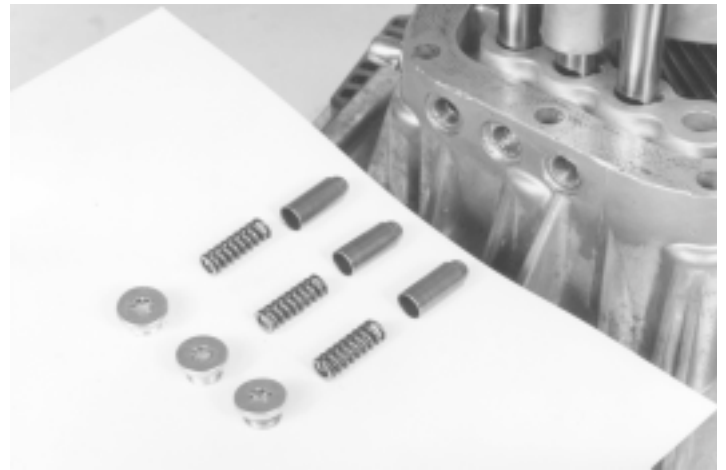

33.- Position the three detent plugs, springs and the detents, as indicated.



34.- Using a 5/32-inch drift and hammer, remove the split pin. From the 1st & 2nd fork and shift rail.



35.-Remove the 1st. & 2nd, fork and shift rail, as indicated.

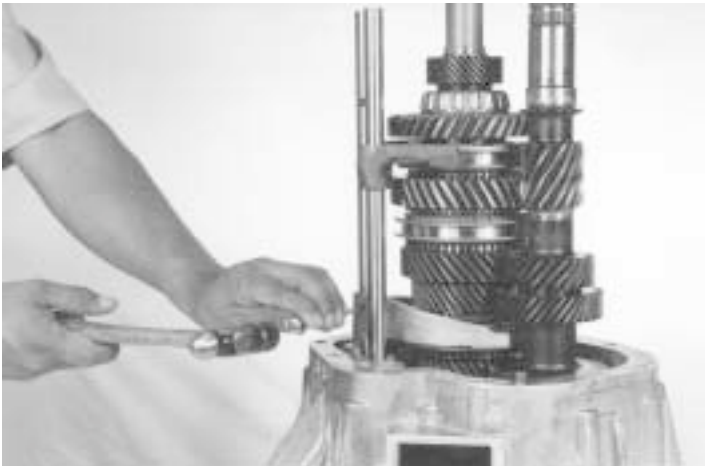

36.- Using a 5/32-inch drift and hammer, remove the split pin from the 3rd & 4th. fork and shift rail.



37.- Remove the 3rd & 4th., fork and rail as indicated.

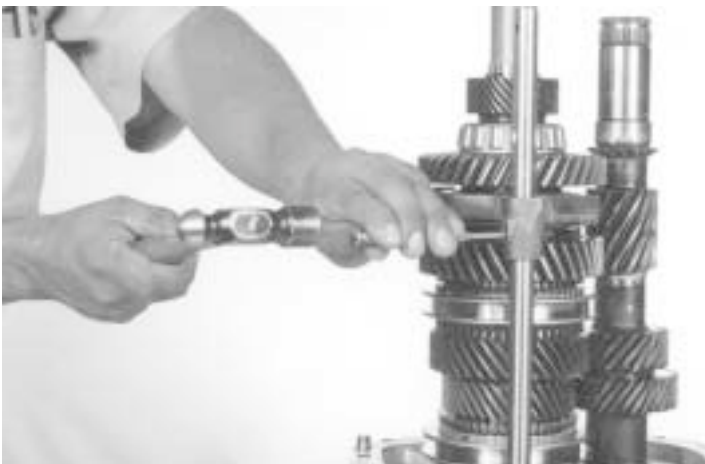

38.-Using a 5/32-inch drift and hammer, remove the split pin from the reverse fork and shift rail.



39.- Remove the reverse fork and rail as indicated.

PRIMARY GEAR PARTS GROUP DISASSEMBLY

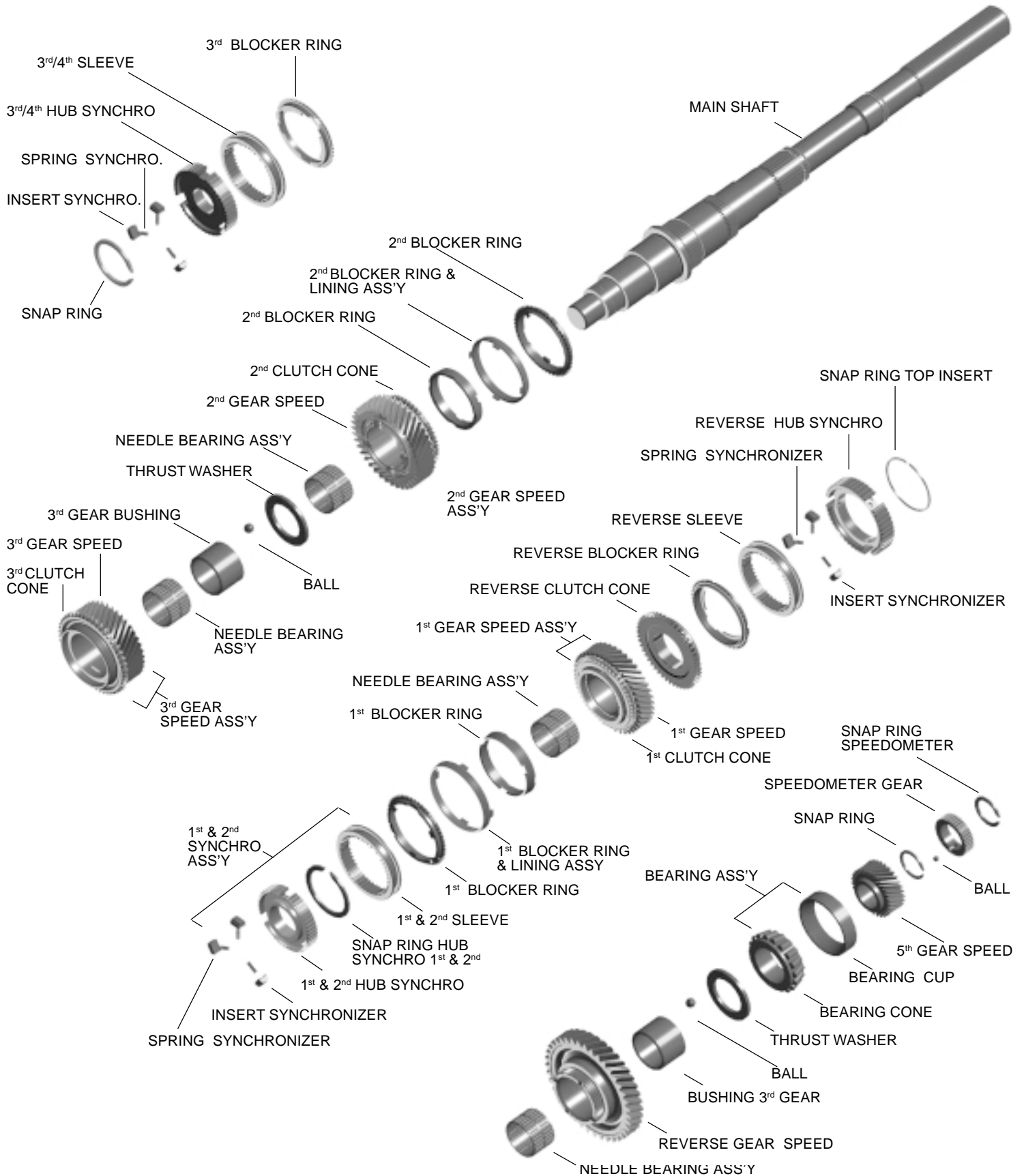



40.- Remove the mainshaft assembly, from the clutch housing, as shown.



41.-Install the mainshaft assembly in a support or vise equipped with soft jaws or wood, shaft front facing up, as indicated.



42- Remove the retaining ring above fifth gear, as shown.



CAUTION:

Support the output shaft while using the press to prevent damage to the shaft or gears.



43- Using a special tool or a press, remove the fifth gear, the spacer, the output shaft bearing and reverse gear from the output shaft bearing.



44.- Remove the locating ball, as shown.



45.- Remove reverse gear needle bearing, as shown.



46.- Remove the reverse gear blocking ring, as indicated.



47.- Remove the clutch cone, as shown.



48.- Remove the first gear, as indicated.



49.-Remove the needle bearing from first gear, as shown.



50.- Remove the first gear synchronizer inner cone, as indicated.



51.- Remove the outer first gear synchronizer cone, as shown.



52.- Remove the first gear synchronizer blocking ring, as indicated.



53.- Rotate the output shaft with the input end facing upward and remove the input shaft bearing race, as shown



54.- With a snap ring plier, remove the hub snap ring, as indicated.



55.- Remove the 3rd & 4th speed synchronizer, as shown.



56.- Remove the 3rd speed synchronizer blocking ring, as indicated.



57.- Remove the third speed gear, as shown.



58.- Remove the third gear needle bearing, as indicated.

NOTE:

Install the special tool behind second gear with the flat side of the tool facing second gear



59.- Using a special tool or a press, remove the spacer, thrust washer and second speed gear



60.- Remove the locating ball, as shown.



61.- Remove the second speed gear needle bearing, as indicated.



62.-Remove the second speed gear synchronizer inner cone, as shown.



63.- Remove the second speed gear synchronizer outer cone, as indicated.



64.- Remove the second speed gear synchronizer blocker ring, as shown.



65.- Using a snap ring pliers, remove the 3rd & 4th hub snap ring, as indicated.



66.- Using a special tool or a press, remove the 3rd & 4th Synchronizer, as shown

SECONDARY GROUP DISASSEMBLY

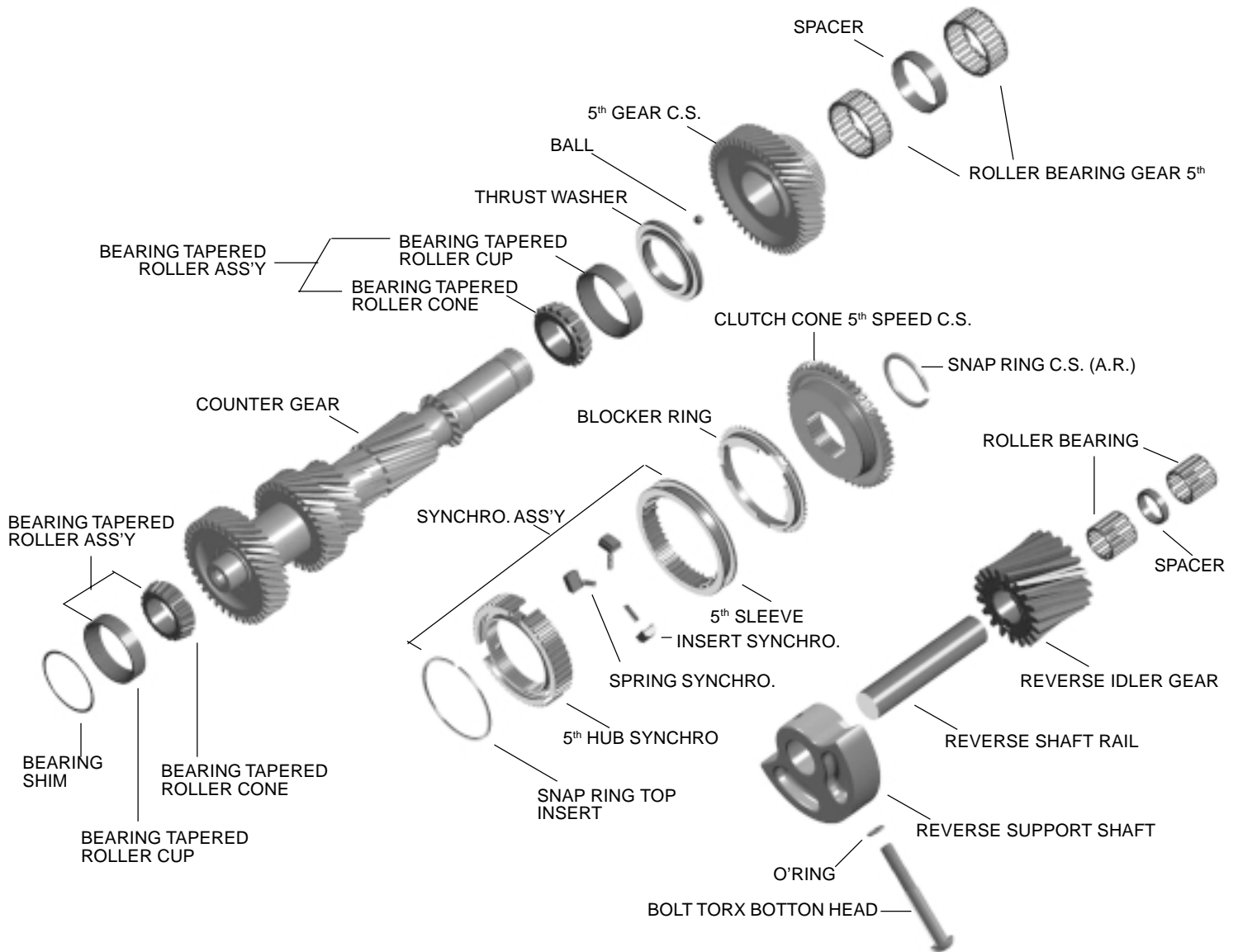

67.- Remove the countershaft, as shown.



68.- Remove the cone bearing, as indicated.

INPUT SHAFT DISASSEMBLY

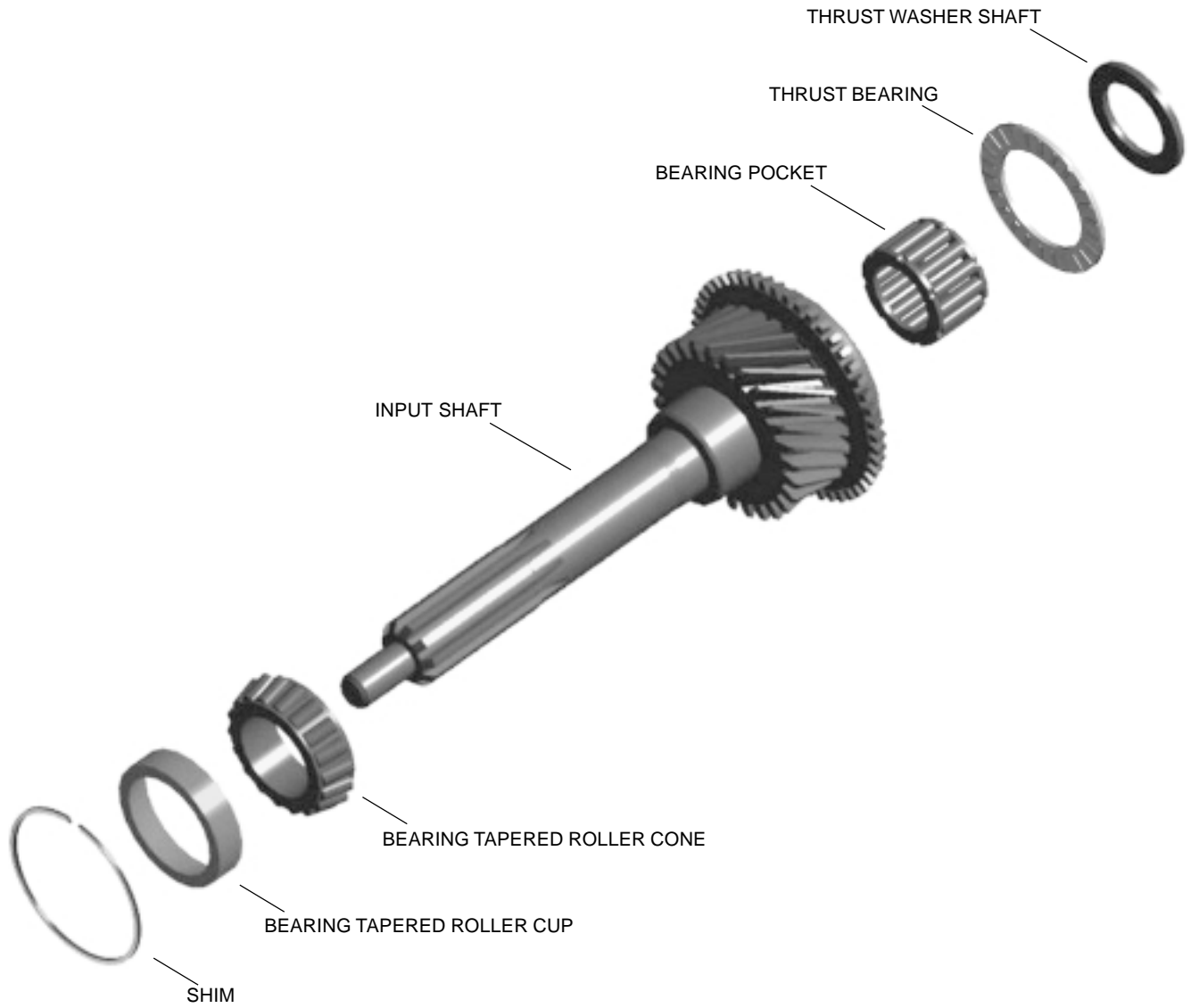

69.- Remove the input shaft, as indicated.

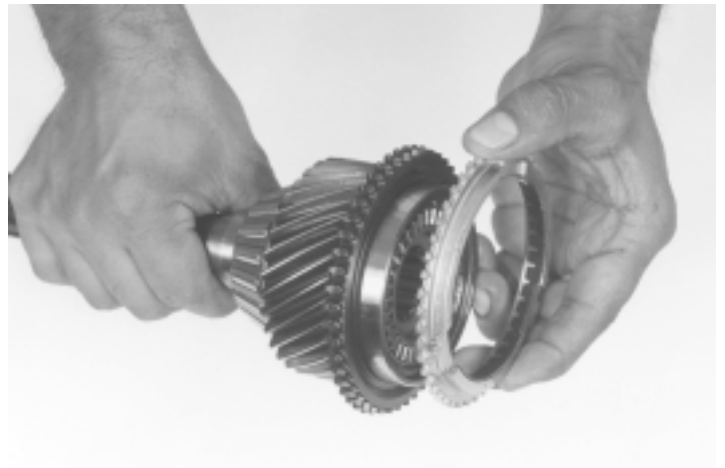

70.- Remove the synchronizer blocking ring, as shown.



71.- Remove the axial bearing, as shown.



72.- Remove the input shaft needle bearing, as shown.



73.- Using a special tool or a press, remove the cone bearing from the input shaft, as shown.

CASE PARTS GROUP DISASSEMBLY

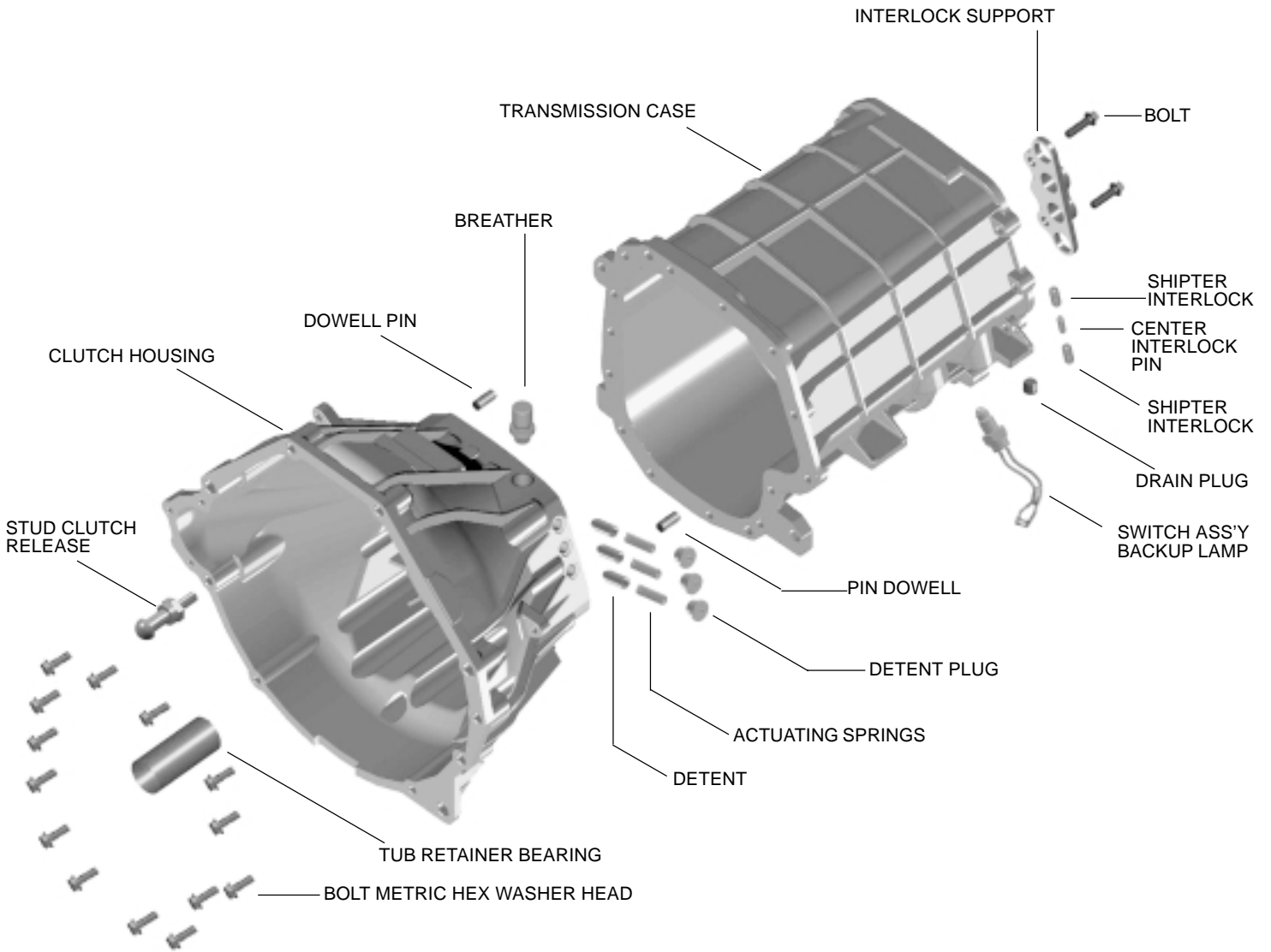

74.- Remove the cup bearing, from the main drive as shown.

75.- Remove the shim bearing, from the main drive as indicate.



76.- Remove the bearing cup, from the counter shaft, as shown.



77.- Remove the bearing shim, from the counter shaft, as indicated.



78.- Remove the input shaft seal, as shown.



79.- Remove the reverse idler shaft bolt. Remove and discard the seal, as indicated.

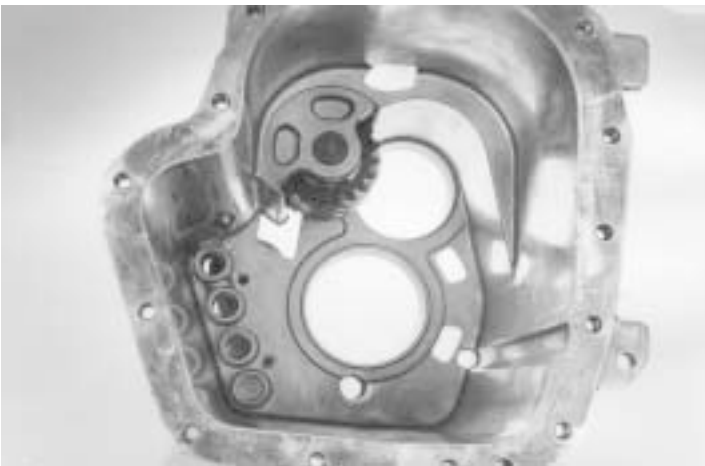

80.- Remove the reverse idler gear assembly, as shown.



81.- Remove the reverse gear, the shaft and support shaft, as indicated.

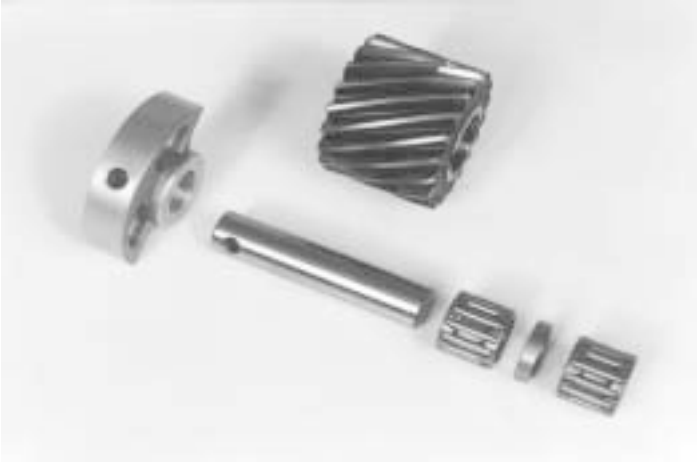

82.-Remove the reverse idler gear bearing. The reverse idler gear is three separate pieces: bearing, spacer, bearing, as shown.



83.- Remove the reverse switch, as indicated.

EXTENSION DISASSEMBLY

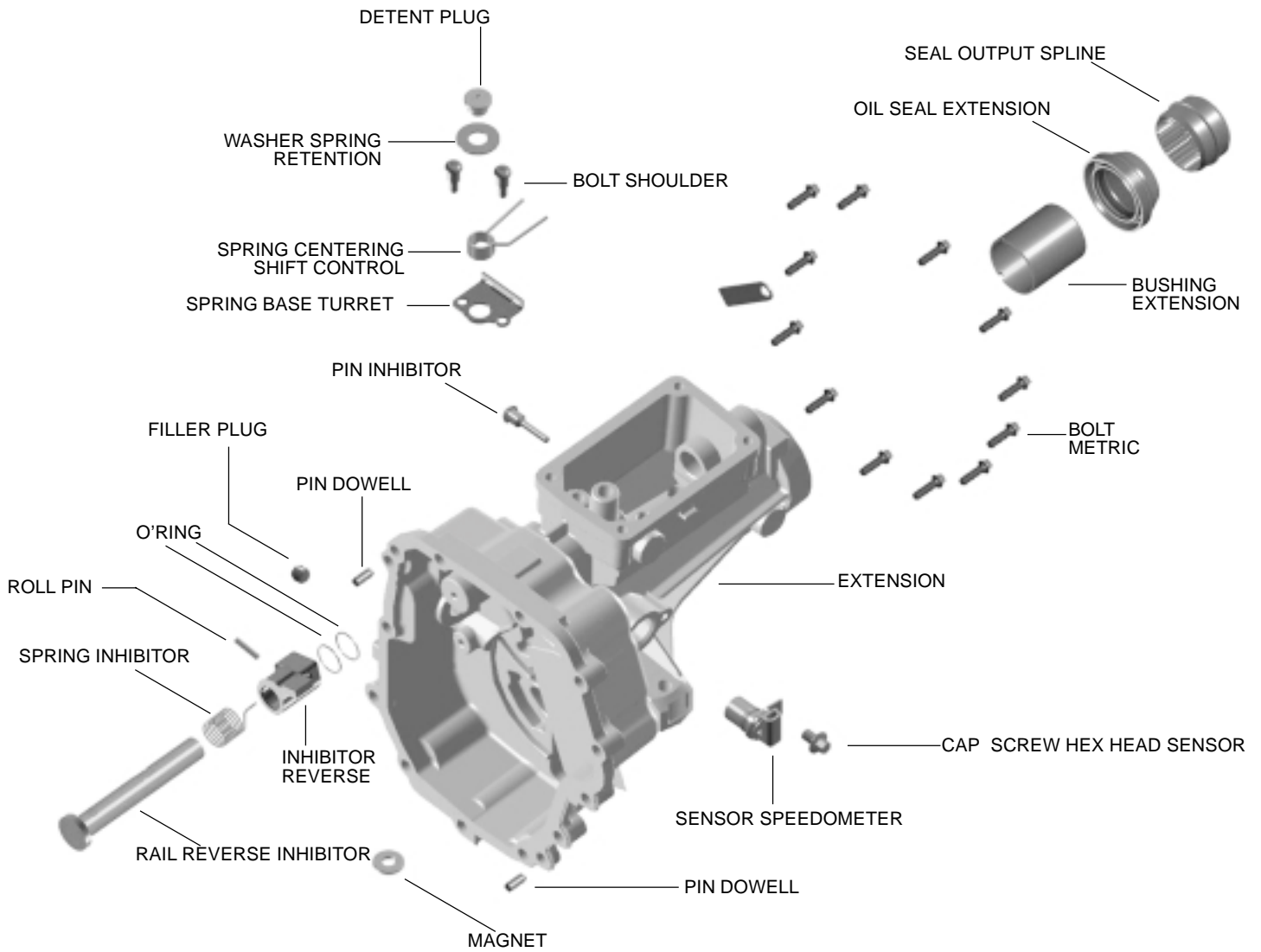

84.- Remove the fifth & reverse inhibitor bolt, as shown.

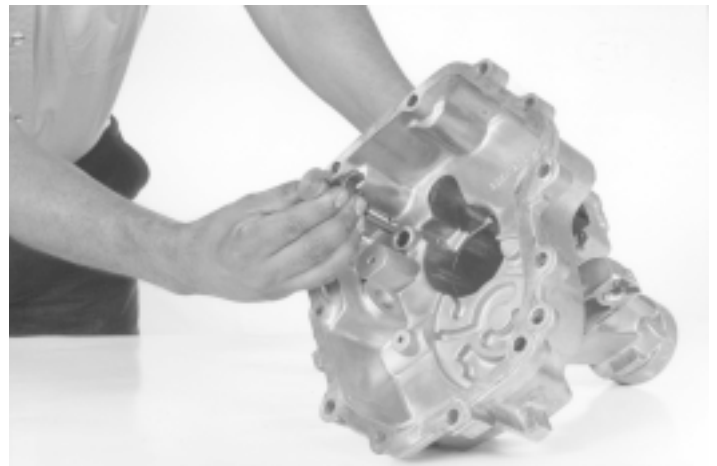

85.-Remove the fifth & reverse lockout inhibitor, as indicated.

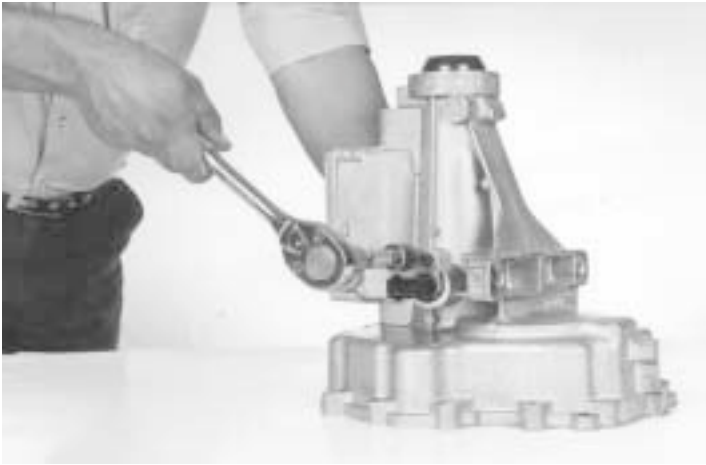

86.- Remove the sensor bolt, as shown.

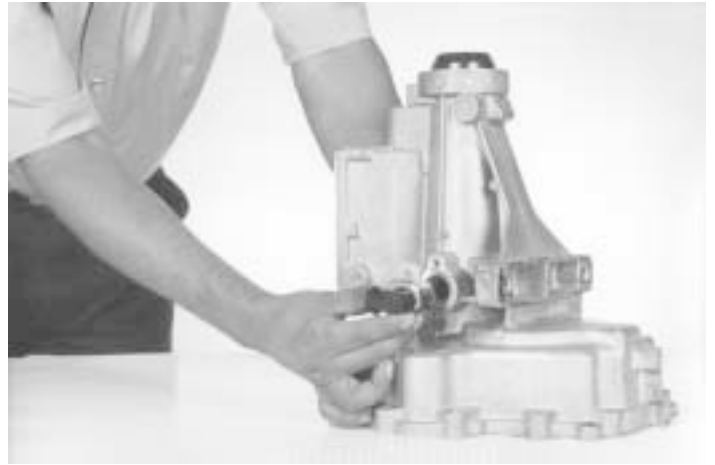

87.- Remove the sensor, as indicated.



88.- Using a special tools, remove the extensión housing fluid seal, as shown.

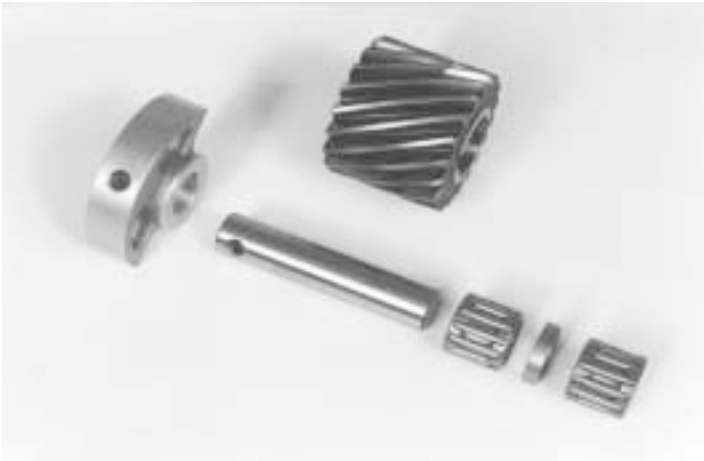

1.-Inspect the gear and bearing for wear or damage. Install new as necessary.

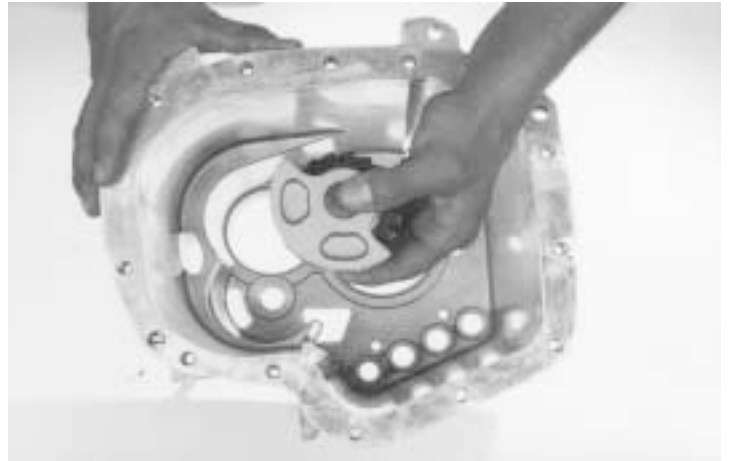

2.- Install the reverse idler gear assembly, as indicated.



3.- Install a new seal and the reverse idler shaft bolt, as shown.



4.- Install the reverse switch, as indicated.



5.- If previously removed, install the extension seal with the proper seal driver.

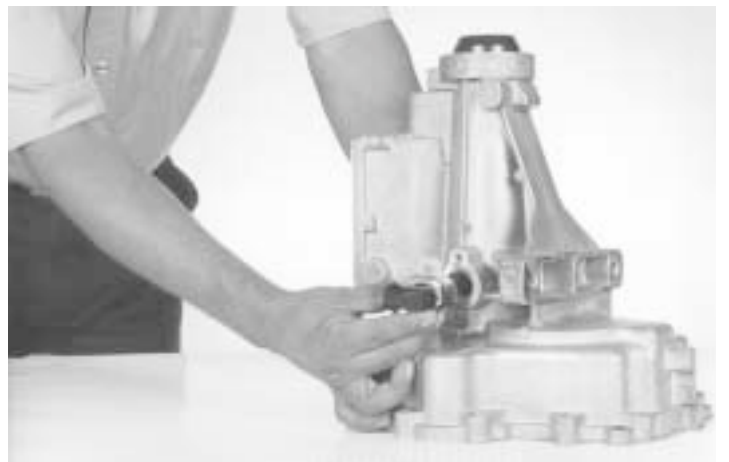

6.-Install the sensor, as indicated.

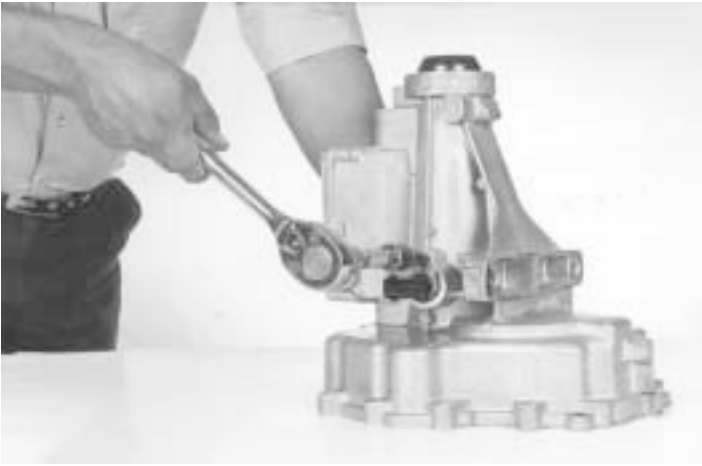

7.- Install the sensor bolt, as shown.

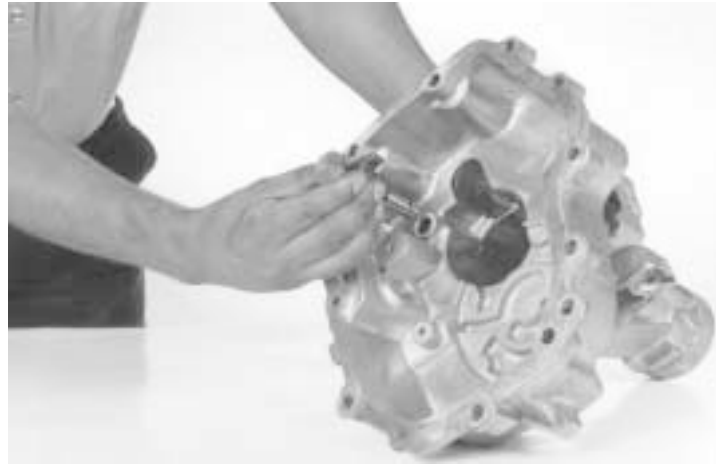

8.- Install the fifth & reverse lockout, as indicated.



9.-Install the fifth & reverse gear lockout bolt, as shown.



10.-Install the mainshaft in a support or vise with soft jaws or wood, shaft front facing up, as indicated.



11.- Install 1st & 2nd synchronizer assembly, as shown



12.- Using a special tool or press, install the 1st & 2nd synchronizer, as indicated.



13.- Using a snap ring plier, install the the of 1st & 2nd hub snap ring, as shown.

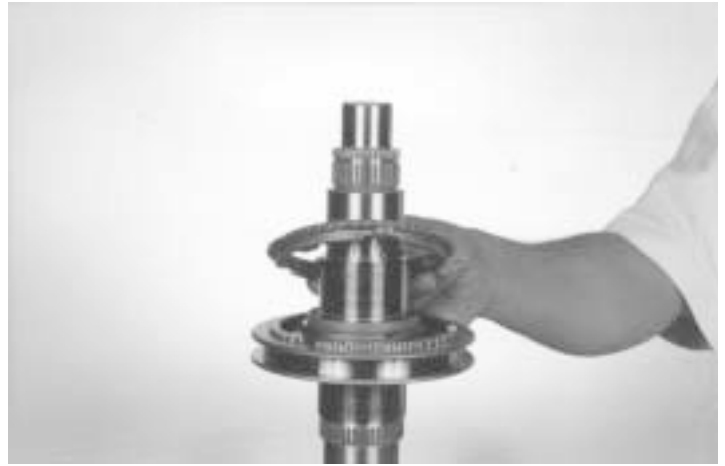

14.- Install the second gear synchronizer blocker ring, align the blocking ring tabs with synchronizer assembly.



15.- Install the second gear synchronizer outer cone, as shown.



16.- Install the second gear synchronizer inner cone, as indicated.



17.- Install the second gear needle bearing, lubricate with the recommended transmission fluid.



18.- Install the 2nd speed gear, as indicated, rotate the gear to align gear slots with inner cone tabs.



19.- Install the locating ball, as shown.



20.- Install the thrust washer, as indicated.



21.- Using a special tool or a press, install the spacer, thrust washer and second speed gear, as shown.



22.- Install the third gear needle bearing, lubricate with the recommended transmission fluid, as shown.



23 .- Install the third speed gear, as indicated.



24 .- Install the 3rd speed synchronizer blocking ring, as shown.



25.- Install the 3rd & 4th speed synchronizer, as indicated.



26.- Using a snap ring plier, install the 3rd & 4th hub snap ring, as shown.



27.- Install the input shaft bearing race, as indicated.



28.- Install the first gear synchronizer blocking ring, align the blocking ring tabs with the synchronizer assembly. Rotate mainshaft with synchronizer up, as shown.



29.- Install the outer first gear synchronizer cone, as shown.



30.- Install the inner first gear synchronizer cone, rotate the inner cone till it is seated, as indicated.



31.- Install the first gear needle bearing lubricate with the recommended transmission fluid.



32.- Install the first speed gear, rotate the gear to align gear slots with the inner cone tabs.



33.- Install the reverse clutch cone, as shown.



34.-Install the reverse gear blocking ring, as indicated



35.-Install the reverse gear bearing spacer, as shown.



36.- Use a special tool or a press to install, as indicated.



37.-Install reverse gear needle bearing, lubricate with the recommended transmission fluid,as shown.



38.- Install reverse gear, rotate gear to align the gear slots with the inner cone tabs.



39.- Using a magnet, Install the ball, use grease to hold the ball in place.



40.- Install the thrust washer. Be sure to align the slot in the washer with the ball.



41.- Instal the bearing cone, as shown.



42.- Use a special tool or a press to install, as indicated.



43.- Intalll the 5th speed gear, as shown.



44.- Use a special tool or a press to install, as indicated.



45- Using a snap ring plier, install the 5th gear snap ring, as indicated.



46.- Using a special tool or press, install the countershaft bearing cone, as shown.



47.- Using a special tool, install the input shaft seal.



48.- Install the appropriate shims to achieve the proper end play, this total gives you a shim pack thickness to start the end play measurement.



49.- Install the front countershaft bearing cup, as indicated.



50.- Install the appropriate shims to achieve the proper end play, this total gives you a shim pack thickness to start the end play measurement.



51.- Install the front input shaft bearing cup, as indicated.



52.- Using a special tool or press, install input shaft bearing cone, as shown.



53.- Install the input shaft needle bearing, as indicated



54.- Install the input shaft bearing, as shown.



55.- Install the synchronizer blocking ring, as indicated.



56.- Install the input shaft, as shown.



57.- Install the countershaft, as indicated.



58.- Install the main shaft assembly, as shown.



59.-Install a tube as a guide when installing the counter shaft bearing cone, as indicated.



60.-Install the countershaft bearing cone, as shown.

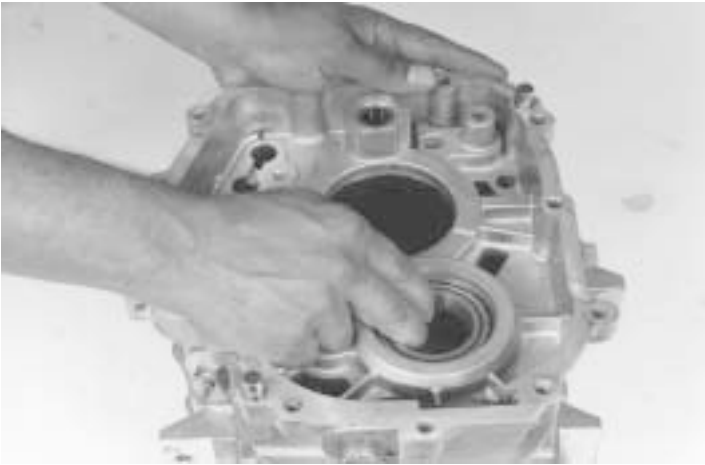

61.- Hold the cone and install the transmission case, as indicated.



62.- Install temporarily the transmission case, as shown.

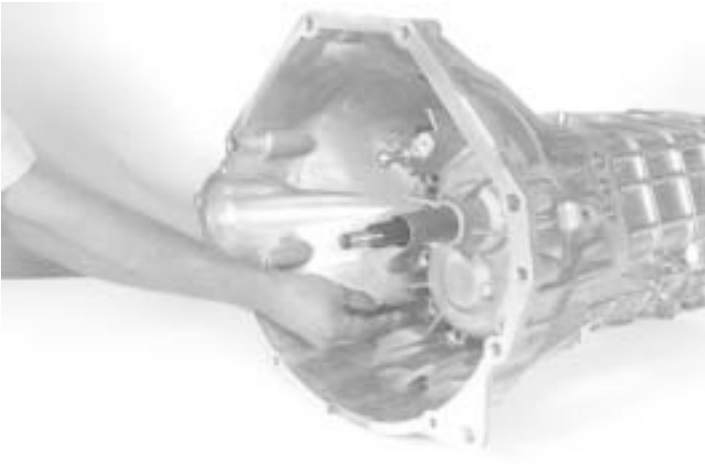

63.- Using a 13 mm socket install the (2) two bolts that hold the case and tighten to the specified torque (18-28 lb-ft), as indicated.

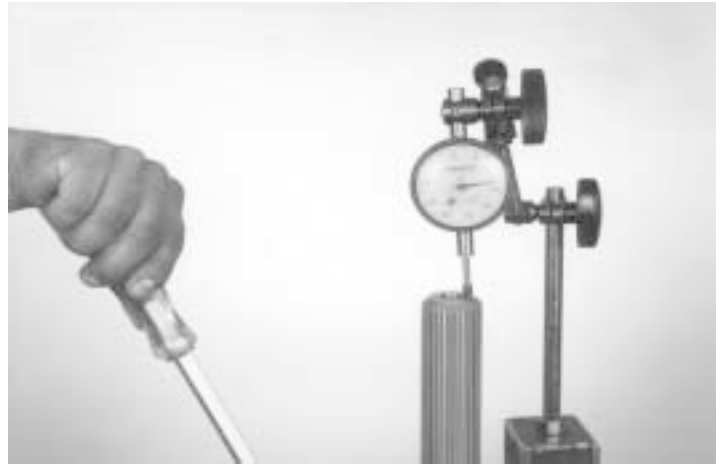

64.- Position a dial indicator as shown on the output shaft pry on the 5th gear. End play must be between 0.001"-0.005"

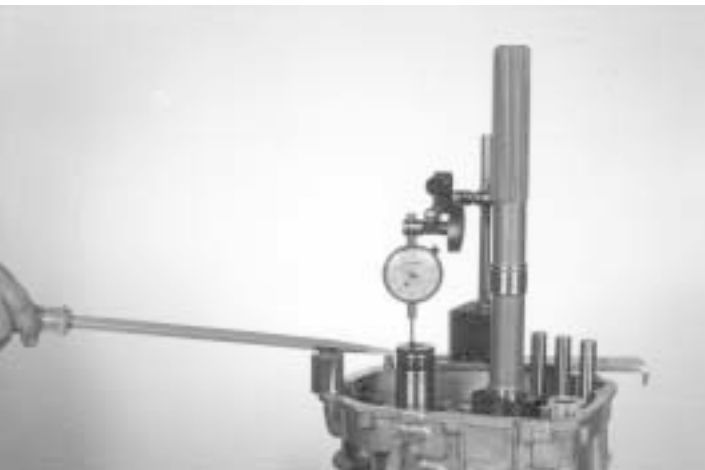

65.-Position a dial indicator as shown on the transmission case pry on countershaft. End play must be between 0.001"-0.005".

NOTE:

Add shims for less end play or remove shims for more end play.

To add or remove shims refer to views 48 & 50

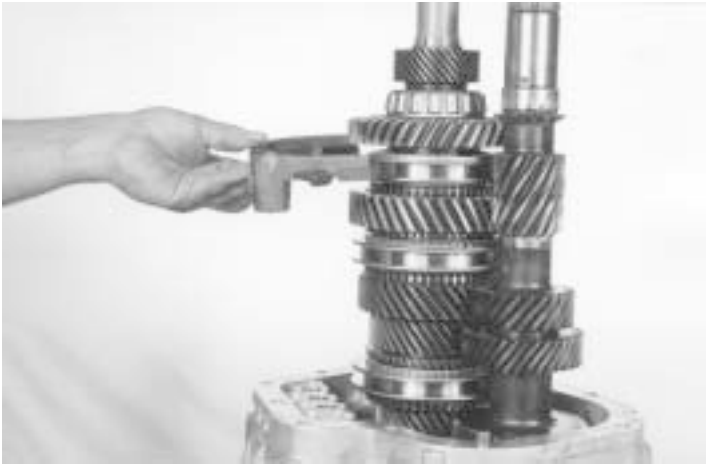

66.- Install the reverse fork, as shown.



67.- Install the reverse & 5th rail, as indicated.

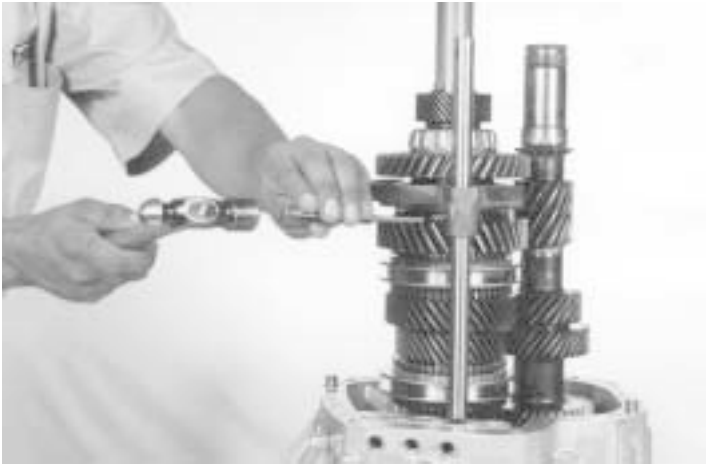

68.- Using a 5/32-inch drift and hammer, install the split pin on the reverse fork and shift rail.

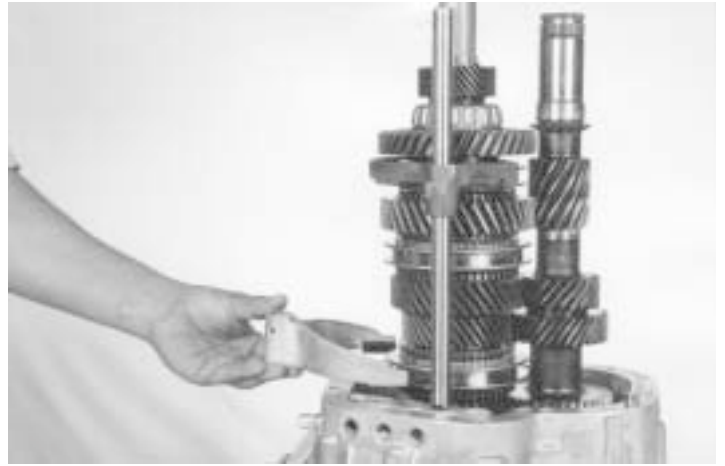

69.- Install the 3rd & 4th fork, as shown.

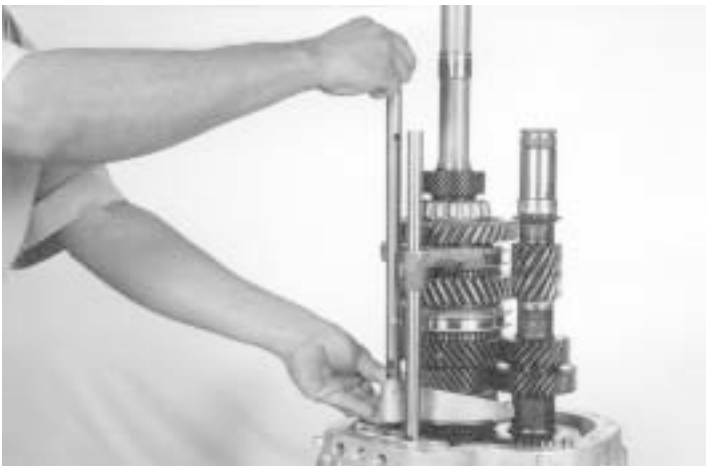

70.- Install the 3rd & 4th rail, as indicated.



71.- Using a 5/32-inch drift and hammer, install the split pin

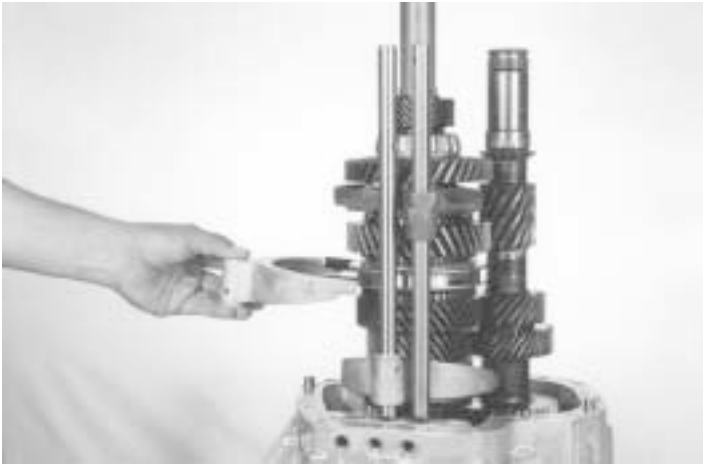

72.- Install the 1st & 2nd fork, as shown.

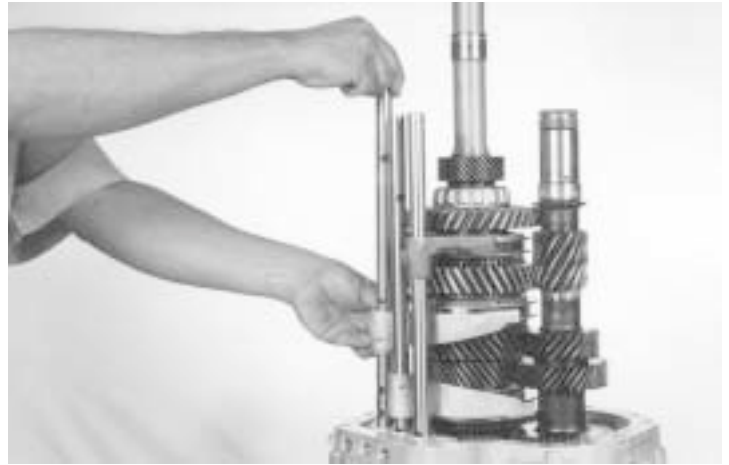

73.- Install the 1st & 2nd rail, as indicated.

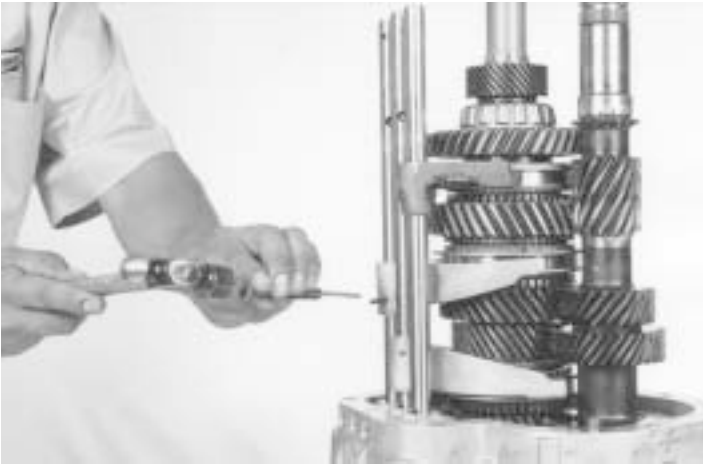

74.- Using a 5/32-inch drift and hammer, install the split pin from the 1st & 2nd fork and shift rail.



75.- Install the detents and detent springs, as indicated.



76.- Install the three detent plugs, as shown



77.- Clean the mating surfaces of the transmission main case and the clutch housing. Apply a bead of silicone rubber to the sealing surface on the clutch housing then install the transmission main case.



78.- Install the transmission case, as shown.

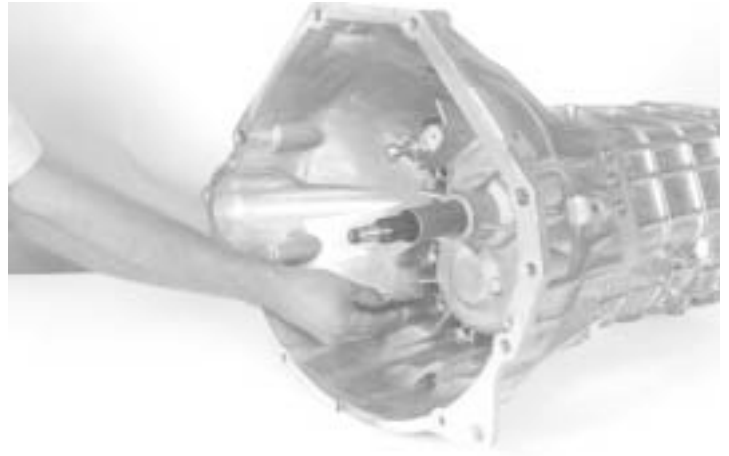

79.-Using a 13 mm socket, install the (14) bolts and tighten to the recommended torque.

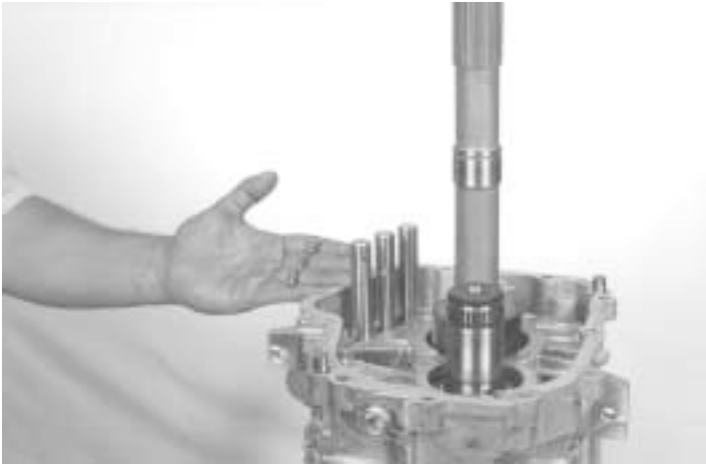

80.- Arrange the lock pin, as indicated.



81.- Using a magnet, install the lock pin in the center rail, as shown



82.- Using a magnet, install the interlock pins, as indicated.

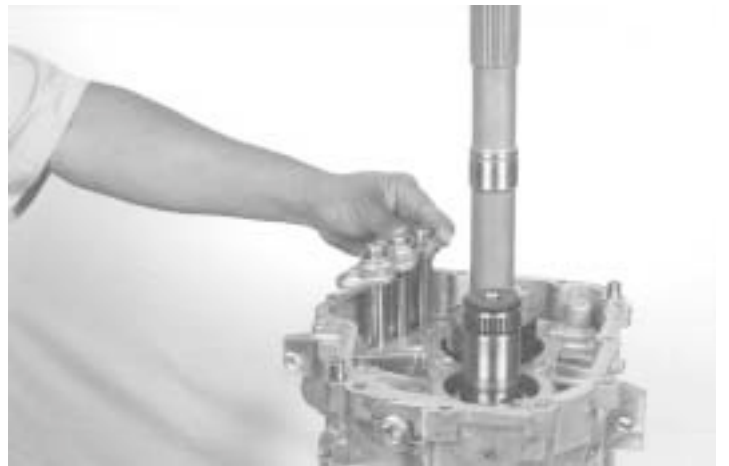

83.- Install the shift interlock plate, as shown.



84.- Install the shift interlock plate bolts, as indicated.

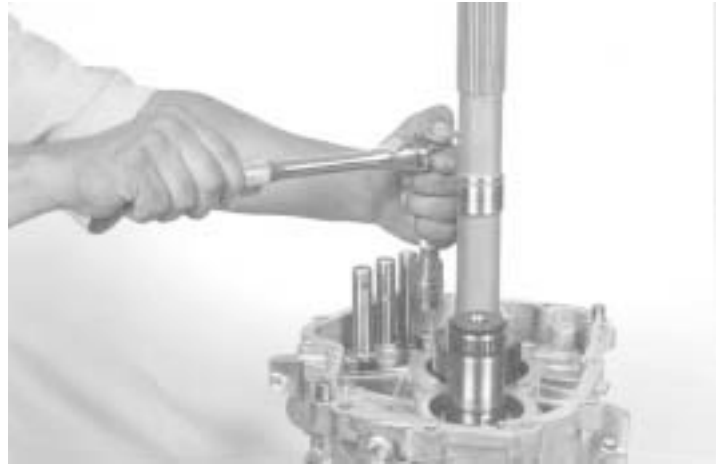

85.- Tighten to the recommended torque



86.- Using a magnet install the locating ball, as indicated.

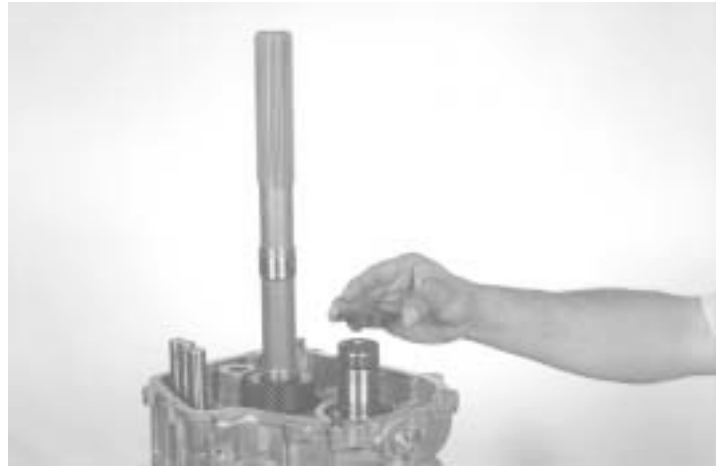

87.- Install the thrust washer, as shown.



88.- Install the two needle bearing and spacer, as indicated.



89.- Install the plastic spacer, as shown.



90.- Install the main shift rail, as indicated.



91.- Install the 1st & 2nd shift finger, as shown.

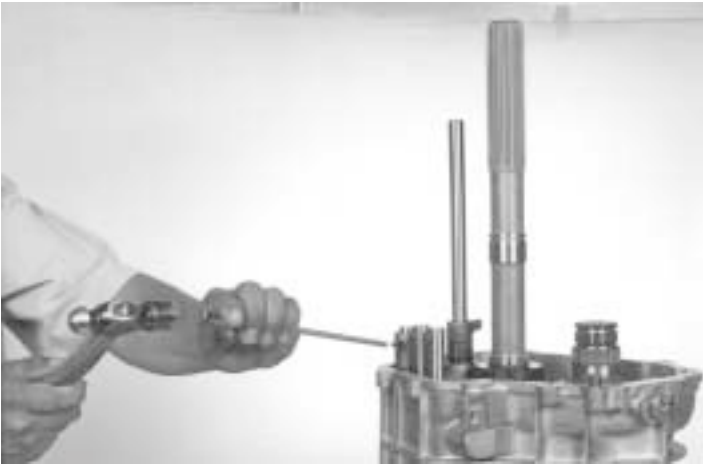

92.- Using a 5/32-inch drift and hammer, install the 1st & 2nd Gate pin on the shift rail, as shown.



93.- Install the 3rd & 4th shift finger, as shown.



94.-Using a 5/32-inch drift and hammer, install the 3rd & 4th gate pin on the shift rail.



95.-Install the 5th gear shift fork, the synchronizer assembly, the synchronizer cone and fifth gear as an assembly.



96.- Using a 5/32-inch drift and hammer, install the 5th fork pin on the shift rail.



97.-Using a snap ring plier, install the 5th gear snap ring, as indicated.



98.- Install the ball for speedometer, using a magnet, as shown.



99.- Install the speedometer sensor, as indicated.



100.-Using the snap ring plier, install the sensor snap ring, as indicated.



101.- Clean the mating surfaces of the transmission main case, and the extension housing. Apply a bead of silicone rubber to the sealing surface of the transmission case.



102.- Install the extension housing and at the same time install the gear shift off-set lever.



103.- Install the (12) bolts and tighten to the recommended torque, as indicated.



104.- Install the fill plug, as shown.



105.-Using a 10 mm. socket tighten to the recommended torque.



106.-Using a 5/32-inch drift and hammer, install the off set lever pin, as shown.

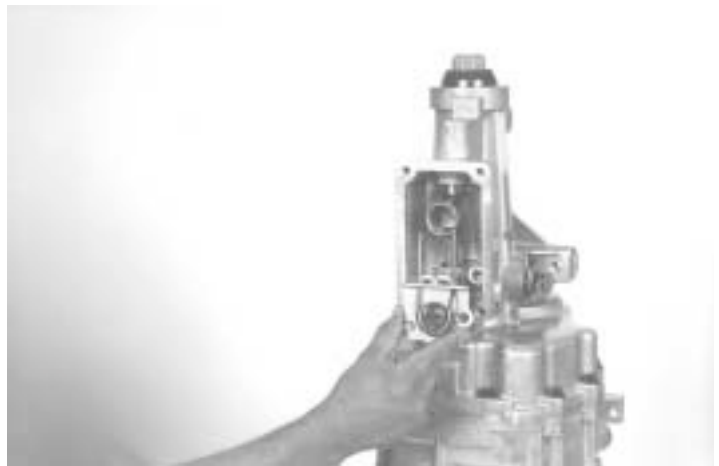

107.- Install the shift spring and plate, as indicated.

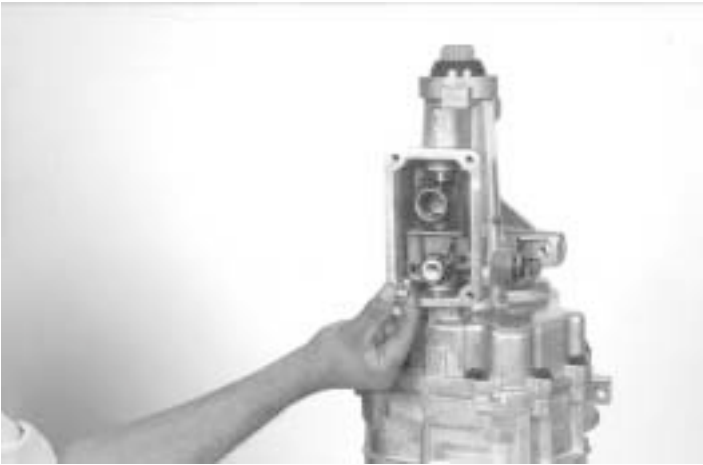

108.- Using a 1/4" socket, install the bolts , as shown.

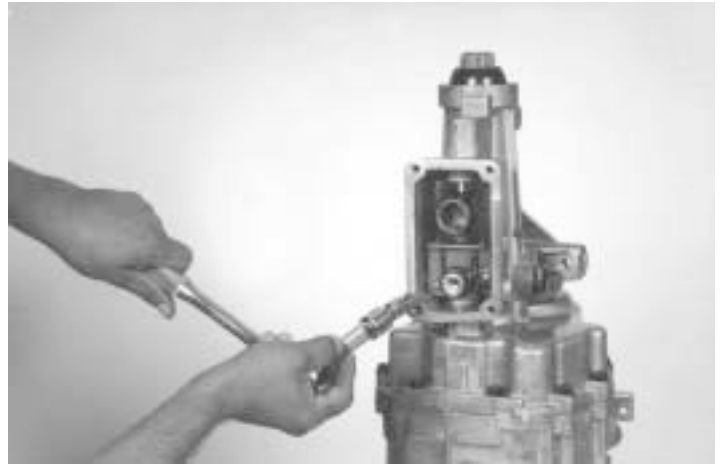

109.-Using a 10 mm socket tighten to the recommended torque, as indicated.

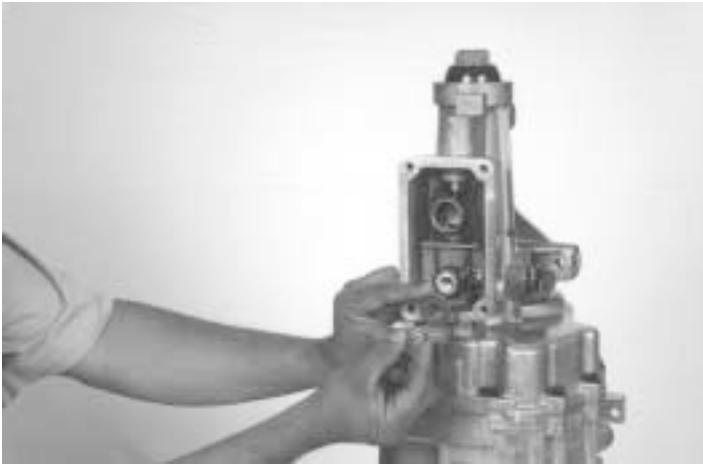

110.-Using a socket, Install the bolt on plate , as shown.

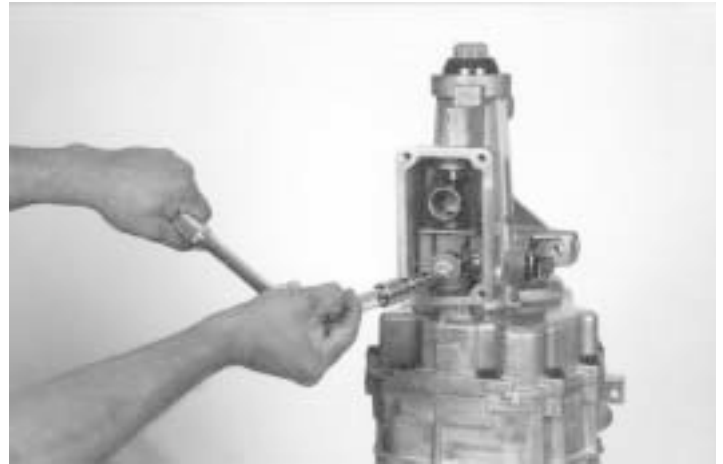

111.-Using a 10 mm socket tighten to the recommended torque, (see torque recommendations).



112.- Install the control turret assembly, as shown



113.- Install the four bolts and tighten to the recommend torque, as indicated.

TR-3650 ON-VEHICLE SERVICE AND TROUBLESHOOTING

PROBLEM	POSSIBLE CAUSE	REMEDY
Will not shift (Control lever Moves)	Control lever assy broken or damaged	Replace control lever and housing assy
	Damaged offset lever, shift plate, or selector, armloose rail bushings. Broken roll pins in offset levers of selector arm.	Remove extension or adapter and case cover. Check for damaged parts. Replace damaged parts.
Hard shift or control lever will not move into gear	Clutch not releasing	Adjust or replace clutch
	Improper or low transmission lubricant	Add or drain and replace with proper lubricant
	Shifter rail binding	Remove extension or adapter and case cover. Check for damaged parts. Replace damaged parts
	Binding of sliding synchronizers or gears	Remove extension and case to check that synchronizers and gears slide freely on shafts. Remove and replace damaged parts
	If reverse only, seized backup switch	Remove and check backup switch. Replace if seized
	Worn or damaged flywheel pilot bushing	Replace pilot bushing
	Bell housing misaligned	Align bell housing to within 0.010 inch TIR on face and in bore
Gears clash when shifting	Engine idle speed too high	Adjust idle speed to specifications
	Clutch damaged or out of adjustment	Adjust or replace clutch
	Bent shift forks or worn fork pads	Disassemble and check. Replace damaged parts
	Damaged synchronizer	Disassemble and check for damaged synchronizer parts. Replace damaged parts
	Pilot bearing between input shaft and output shaft binding	Disassemble and check bearing rollers, input shaft ID and output shaft OD. Replace damaged parts
	Bell housing misaligned	Align bell housing to within 0.010 inch TIR on face and in bore
	Damaged gears	Disassemble and check for gear damage. Replace damaged gears
	Worn or damaged flywheel pilot bushing	Replace pilot bushing

PROBLEM	POSSIBLE CAUSE	REMEDY
Transmission jumps out of gear	Synchronizer damaged or excessively worn	Disassemble and check for worn or damaged synchronizer parts. Replace damaged parts.
	Blocking ring damaged, worn index slots or friction surfaces worn or damaged	Disassemble and check blocking ring for wear or damage. Replace worn or damaged parts
	Excessive countershaft end play	Disassemble and check. Replace worn or damaged parts. Reshim if necessary
	Shifting fork loose on shift rail; worn or damaged fork or fork pads	Disassemble and check for wear or damage. Replace worn or damaged parts
Transmission locked in one gear	Fork or offset lever loose on shift rail	Remove extension and case to check for loose parts on shift rail. Replace roll pin(s). If still loose, replace shift rail and/or attached parts as required
	Worn or damaged forks, offset lever, shift rail, broken roll pins in offset levers.	Remove extension or adapter and case cover. Check for wear or damage. Replace damaged parts.
	Worn or damaged synchronizer	Disassemble and check for worn or damaged synchronizer parts. Replace worn or damaged parts.
	Worn or damaged gears	Disassemble and check for worn or damaged gears. Replace worn or damaged gears.
Transmission noise NOTE: Make sure noise is coming from transmission and not clutch release bearing or other components.	Improper or low transmission lubricant	Add or drain and replace with proper lubricant.
	Loose bolts or other attaching parts	Make sure all attaching parts are torqued to specifications
	Improper flywheel housing to engine crankshaft alignment	Check alignment and correct if necessary per vehicle service manual
	Noisy transmission bearings	Disassemble and check bearings, bearing rollers and parts in and on which they operate for wear or damage. Replace worn or damaged parts
	Noisy gears	Disassemble and check for worn or damaged gears (including speedometer gear). Replace worn or damaged gears

PROBLEM	POSSIBLE CAUSE	REMEDY
Transmission leakage	Leakage from other components	Verify transmission leakage. Thoroughly clean all exposed surfaces, then check for leaks
	Vent or breather clogged	Remove vent tube and clean or replace
	Too much or improper lubricant	Remove fill plug to check for excess, or drain and replace
	Loose bolts at sealing faces	Torque bolts to specifications
	Improperly applied sealant	Separate and thoroughly clean leaking surfaces. Reapply sealant. Replace parts and torque bolts to specifications
	Worn or damaged oil seal	Replace oil seal
	Shifter base loose	Replace shifter assembly
High effort shift from 5 gate to reverse gate	Reverse lockout assembly	Check lockout assembly function Replace parts as required

TORQUE WRENCHES



PULLERS BEARING AND BEARING SEPARATORS



SOCKET SET



40 TORK, 40 TORK PLUS



FEELER GAGES



BALL PEIN HAMMER



SOFT FACET HAMMER



PLIERS



SNAP RING PLIERS



HEX KEY SET



GASKET ELIMINATOR



DRIFT PUNCHES

